

DESCRIPTION	ORDERING CODE
Illumipod 18 IP Optic 15 RCB	11018001
Illumipod 18 IP Optic 30 RCB	11018004
Illumipod 18 IP Optic 30 VVV 2:1	11018010

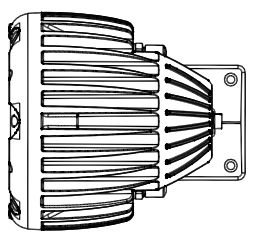
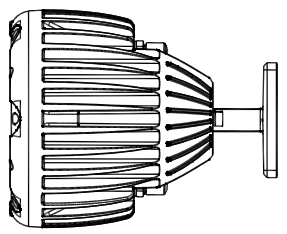
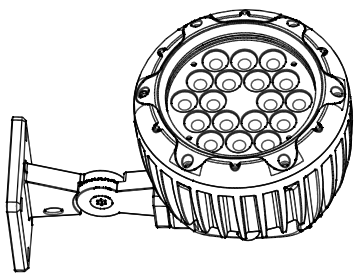
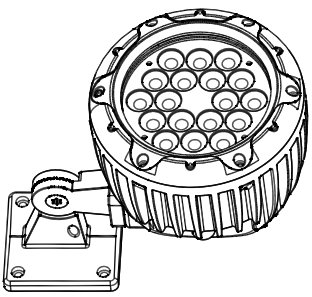
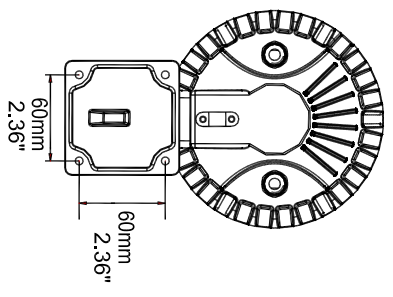
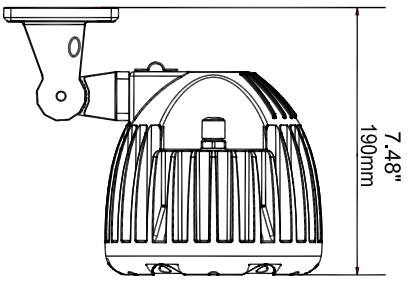
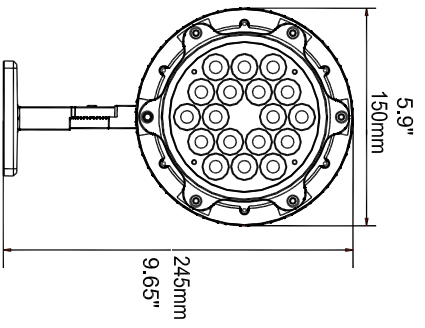
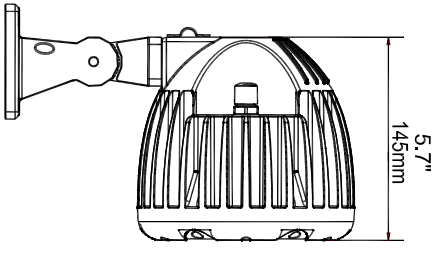

DATE: 4/15/09	DWG# 11018000	REV# 0	PG# 1
ILLUMINARC			
Illumipod 18 IP Optic RGB			