

# **Ilumipod Inground IP Series**

## **User Manual**

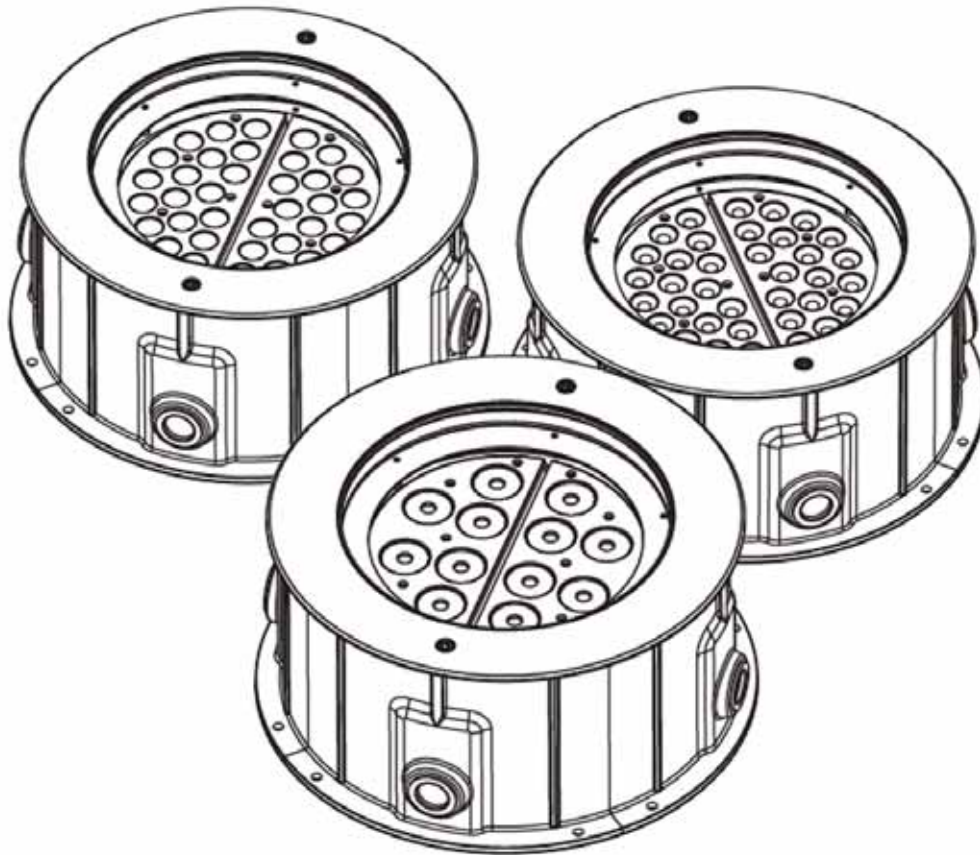

**ILUMINARC®**

---

## Edition Notes

The Ilumipod Inground IP Series User Manual Rev. 01f covers the description, safety precautions, installation, programming, operation, and maintenance of the Ilumipod Inground 36 IP RGB, Ilumipod Inground 36 IP VW, and Ilumipod Inground Tri-12 IP products. ILUMINARC® released this edition of the Ilumipod Inground IP Series User Manual Rev. 01f in July 2011.

### Trademarks

The ILUMINARC® logo, the ILUMINARC® name, and all other trademarks in this document related to services or products by ILUMINARC® are trademarks owned or licensed by ILUMINARC®, its affiliates, or subsidiaries. Any other product names, logos, brands, company names, or trademarks featured or referred to within this document are the property of their respective trademark holders.

### Copyright Notice

The entire content of this document, except where applicable and unless otherwise noted, is solely owned by ILUMINARC®, a wholly owned trademark of CHAUVET & Sons Inc.

© Copyright 2011 ILUMINARC®

All rights reserved.

Electronically published by ILUMINARC® in the United States of America.

### Manual Usage

ILUMINARC® authorizes its customers to download and print this manual for professional information purposes only. ILUMINARC® expressly prohibits the usage, copy, storage, distribution, modification, or printing of this manual or its content for any other purpose without its written consent.

### Document Printing

For better results, print this document in color, on letter size paper (8.5 x 11 inches), double sided. If using A4 paper (210 x 297 mm), configure your printer to scale the content of this document to A4 paper.

### Intended Audience

Any person in charge of installing, operating, and/or maintaining any of these products should read the Guide that shipped with it and this manual in their entirety before installing, operating, or maintaining the product.

### Disclaimer

ILUMINARC® believes that the information contained in this manual is accurate in all respects. However, ILUMINARC® assumes no responsibility for any error or omissions in this document. ILUMINARC® reserves the right to revise this document and to make changes from time to time in the content hereof without obligation of ILUMINARC® to notify any person or company of such revision or changes. This does not constitute in any way a commitment by ILUMINARC® to make such changes. ILUMINARC® may issue a revision of this manual or a new edition of it to incorporate such changes.

### ILUMINARC® Publications Hot Line

If you have any comments about the accuracy of this document or general suggestions regarding how we can improve it, please call us at (954) 923-3680. You can download the latest versions of all ILUMINARC® products' manuals from [www.iluminarc.com](http://www.iluminarc.com).

### Document Revision

The Ilumipod Inground IP Series User Manual Rev. 01f supersedes all previous versions of this manual. Please discard any older versions of this manual you may have, whether in printed or electronic format, and replace them with this version.

# Table of Contents

<b>1. Introduction.....</b>	<b>1</b>
What is in the Box .....	1
Unpacking Instructions .....	1
Text Conventions .....	1
Safety Notes.....	2
<i>Personal Safety</i> .....	2
<i>Installing</i> .....	2
<i>Power and Wiring</i> .....	2
<i>Operation</i> .....	2
<b>2. Product Description .....</b>	<b>3</b>
Common Features.....	3
<i>Illumipod Inground 36 IP VW Features</i> .....	3
<i>Illumipod Inground 36 IP RGB Features</i> .....	3
<i>Illumipod Inground Tri-12 IP Features</i> .....	3
Product Dimensions .....	4
<b>3. Installation.....</b>	<b>5</b>
Installation Notes.....	5
<i>Installation Sleeve Orientation</i> .....	5
<i>Installation Sleeve Setup</i> .....	5
<i>Beam Angle Adjustment</i> .....	6
AC Power .....	7
<i>Input Voltage and Frequency</i> .....	7
<i>Power Consumption</i> .....	7
Junction Box Wiring.....	7
<i>Power Wiring</i> .....	7
<i>Signal Wiring</i> .....	8
External Wiring .....	8
<i>Power Distribution</i> .....	8
<i>Signal Distribution</i> .....	8
Controllers .....	9
<i>DMX Controller</i> .....	9
<i>ILUMICON</i> .....	9
<i>Illumicode</i> .....	10
<b>4. Operation.....</b>	<b>11</b>
Illumicode .....	11
<i>Illumicode Panel Description</i> .....	11
Menu Map .....	11
<i>White Functions Menu Map</i> .....	11
<i>RGB Functions Menu Map</i> .....	12
Programming.....	13
<i>DMX Personality</i> .....	13
<i>DMX Starting Address</i> .....	13
<i>Dimmer</i> .....	13
<i>ILUMICON Control</i> .....	14
<i>Static Color</i> .....	14
<i>Color Calibration</i> .....	14
<i>Color</i> .....	14
<i>Reset</i> .....	14
DMX Values .....	15
<i>ARC 1</i> .....	15
<i>ARC 1 + D</i> .....	15
<i>ARC FULL</i> .....	15
<i>SPECIAL 1</i> .....	16
<i>VW</i> .....	16
<i>VW + D</i> .....	16

---

SOLID.....	16
<b>5. Technical Information .....</b>	<b>17</b>
Product Maintenance .....	17
Product Repairs.....	17
Troubleshooting Guide.....	18
Exploded View.....	19
Photometrics .....	20
<i>Illumipod Inground 36 IP 15° VW .....</i>	<i>20</i>
<i>Illumipod Inground 36 IP 30° VW .....</i>	<i>21</i>
<i>Illumipod Inground 36 IP 15° RGB .....</i>	<i>22</i>
<i>Illumipod Inground 36 IP 30° RGB .....</i>	<i>23</i>
<i>Illumipod Inground Tri-12 IP 16°.....</i>	<i>24</i>
LED Disclaimer.....	25
<i>LED Life.....</i>	<i>25</i>
<i>LED Binning.....</i>	<i>25</i>
<i>Color Rendering Index (CRI).....</i>	<i>25</i>
Returns Procedure .....	26
Claims.....	26
Contact Us.....	26
Technical Specifications.....	27
<i>Illumipod Inground 36 IP VW.....</i>	<i>27</i>
<i>Illumipod Inground 36 IP RGB.....</i>	<i>28</i>
<i>Illumipod Inground Tri-12 IP .....</i>	<i>29</i>

# 1. Introduction



This icon indicates useful, although non-critical information.



This icon indicates important installation or configuration information. Failure to comply with this information may prevent the product from functioning correctly.



This icon indicates critical installation, configuration, or operation information. Failure to comply with this information may render the product partially or completely inoperative, damage third-party equipment, or cause harm to the user.



The term “DMX” used throughout this document refers to the USITT DMX512-A transmission protocol.

## What is in the Box

- One Ilumipod Inground IP product (36 IP RGB, 36 IP VW, or Tri-12 IP)
- Warranty Card
- Quick Reference Guide

## Unpacking Instructions

Immediately upon receiving a product from ILUMINARC®, carefully unpack the carton. Check the contents of the box to ensure that all parts are present and that they are in good condition. If any part appears damaged from shipping, or if the carton shows signs of mishandling, see the *Claims* section in the *Technical Information* chapter.

## Text Conventions

Convention	Meaning
<b>1~512</b>	A range of values in the text
<b>50/60</b>	A set of mutually exclusive values in the text
<b>“ILUMICON UM”</b>	The name of another publication or manual
<b>&lt;SET&gt;</b>	A button on the product’s control panel
<b>SETTINGS</b>	A product function or a menu option
<b>MENU &gt; SETTINGS</b>	A sequence of menu options
<b>1~10</b>	A range of menu values from which to choose in a menu
<b>Yes/No</b>	A set of two mutually exclusive menu options in a menu
<b>ON</b>	A unique value to enter or select in a menu



*There are no user serviceable parts inside this product. Any reference to servicing you may find in this User Manual will only apply to properly ILUMINARC® authorized technicians. Do not open the housing or attempt any repairs unless you are an ILUMINARC® authorized technician.*



*Please refer to all applicable local codes and regulations for the proper installation of this product.*



*Keep this manual for future consultation. If you sell this product to another user, make sure that they also receive this manual.*



*In the unlikely event that your Illumipod Inground IP product may require service, please contact ILUMINARC® Technical Support.*

## Safety Notes

Please read all the following safety notes carefully because they include important information on how to install, use, and maintain this product safely.

### Personal Safety

- Avoid direct eye exposure to the light source while the product is on.
- Always disconnect the Illumipod Inground IP product from its power source before servicing.
- Always connect the Illumipod Inground IP product to a grounded circuit to avoid the risk of electrocution.

### Installing

- The Illumipod Inground IP products are for outdoor use and they can work while submerged in up to 1 m of water (IP67) for 30 min.
- Observe the installation instructions regarding drainage to ensure that the water level is never higher than 1 m to comply with the IP67 rating.

### Power and Wiring

- Always make sure that you are connecting this product to the proper voltage, as per the specifications in this manual or on the product's sticker.
- Never connect this product to a dimmer pack.
- Make sure that the power cable is not cracked, crimped, or damaged.
- Make sure that the sealed cover is properly adjusted to avoid water entering the unit.

### Operation

- The maximum ambient temperature (Ta) is 104° F (40° C). Do not operate this product at a higher temperature.
- In case of a serious operating problem, stop using this product immediately!

## 2. Product Description

The Ilumipod Inground IP Series includes three separate products: Ilumipod Inground 36 IP RGB, Ilumipod Inground 36 IP VW, and Ilumipod Inground Tri-12 IP.

### Common Features

- Remotely addressable DMX-512 LED inground wash light
- IP67 ingress protection
- IP67 stainless steel gland nuts for cable entry
- Adjustable module angle
- Cast aluminum and stainless steel housing
- Impact resistant glass lens cover (drive-over rated)
- Polished stainless steel mounting ring
- Ilumicode compatible
- ILUMICON compatible



*Other than their LED configuration and programming features, these three products share the same dimensions, as well as the installation, wiring, and troubleshooting procedures.*

### ***Ilumipod Inground 36 IP VW Features***

- Operating modes:
  - 1-channel: Dimmer
  - 2-channel: Warm white, cool white
  - 3-channel: Warm white, cool white, dimmer
- High power 1 W (750 mA) Warm White and Cool White LEDs
- Installed (non-changeable) optical system:
  - 15° lenses Product order code: 11036010
  - 30° lenses Product order code: 11036008

### ***Ilumipod Inground 36 IP RGB Features***

- Operating modes:
  - 1-channel: Dimmer
  - 3-channel: RGB control
  - 4-channel: RGB, dimmer
  - 6-channel: RGB per module
  - 7-channel: RGB, dimmer, macro, strobe, dimming speed
- High power 1 W (750 mA) Red, Green, and Blue LEDs
- Blackout/static/dimmer/strobe/pulse
- Installed (non-changeable) optical system:
  - 15° lenses Product order code: 11036009
  - 30° lenses Product order code: 11036007

### ***Ilumipod Inground Tri-12 IP Features***

- Operating modes:
  - 1-channel: Dimmer
  - 3-channel: RGB control
  - 4-channel: RGB, dimmer
  - 6-channel: RGB per module
  - 7-channel: RGB, dimmer, macro, strobe, dimming speed
- High power 3 W (1,050 mA) tri-color LEDs
- Blackout/static/dimmer/strobe/pulse
- Installed (non-changeable) optical system:
  - 16° lenses Product order code: 11012001



*The lenses in these three products are non-changeable.*

*Therefore, make sure to use the right product order code for the desired lens angle.*

### Product Dimensions

(All Ilumipod Inground IP Series models)

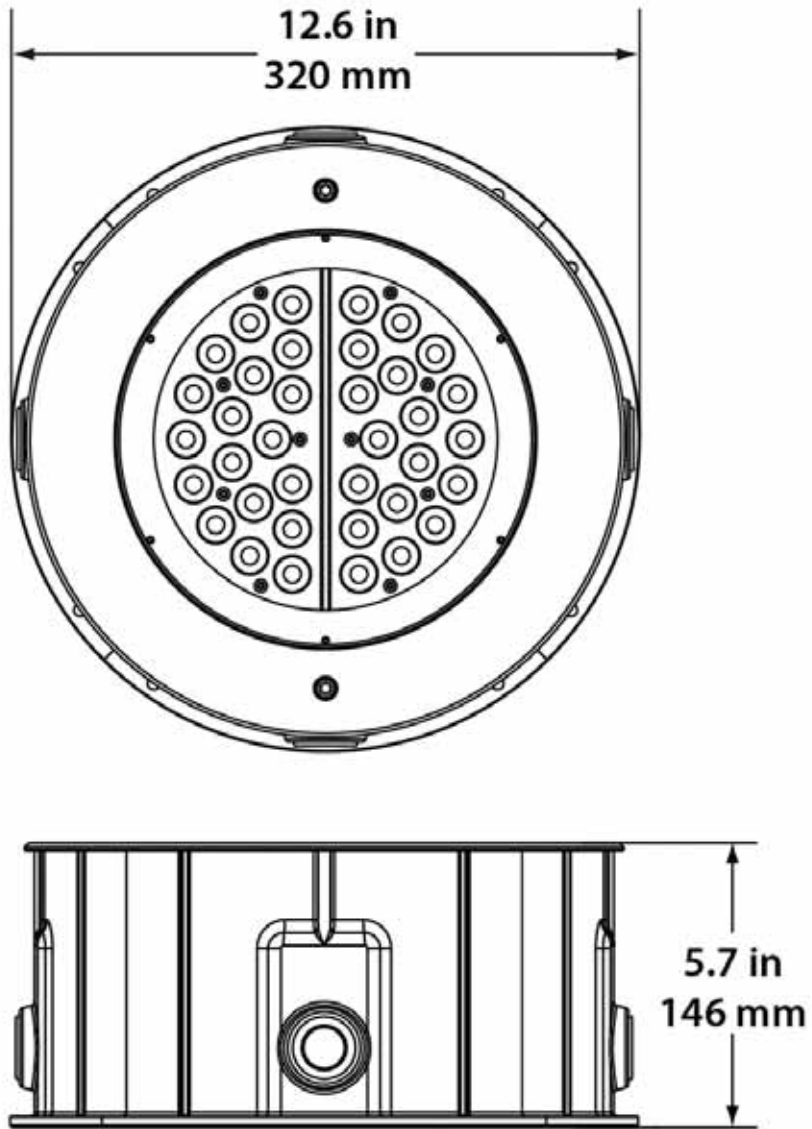

### 3. Installation

#### Installation Notes

The Ilumipod Inground IP products consist of two parts, the product housing and the concrete installation sleeve. The product housing is IP67 rated, but the installation sleeve is not.

Carefully read the installation instructions for the concrete installation sleeve regarding leveling and drainage.

You will have to run the AC power and signal cables into the concrete installation sleeve and the product's housing.

Do not use the product's junction box to extend the power or signal cables to other units because it may compromise the IP rating of the junction box. Instead, use individual cables from the product to the corresponding distribution boxes.

**i** Always keep the power cables away from the signal cables by running them in different conduits and using separate distribution boxes.

#### Installation Sleeve Orientation

Orient the installation sleeve to allow the signal cable to enter the sleeve using one of the four cable inlets and the power cable to use the opposite inlet, as seen in the following figure. This will reduce the stress to the signal and power cables when setting down the product, while keeping them separated under the product's housing.

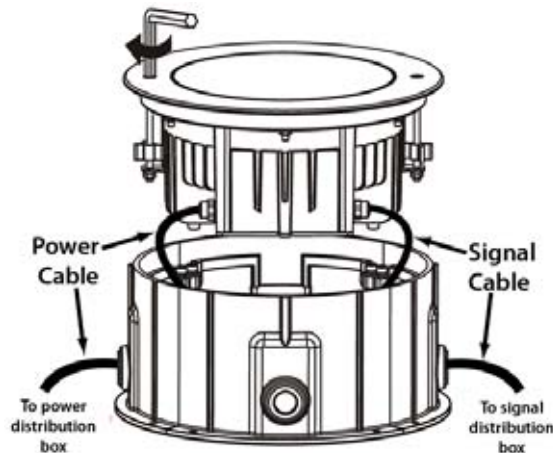

#### Installation Sleeve Setup

When setting up the installation sleeve, make sure any water that entered the sleeve can drain out on its own. Locate the installation sleeve above the normal drainage level so the product is never under more than 1 m of water (IP67) during heavy rain.

In addition, make sure that the installation sleeve and the stainless steel collar are horizontal and even with the ground surface. This helps to distribute the load uniformly over the product's surface and avoids creating dangerous bumps.

**!** Ilumipod Inground IP products can support a distributed load of up to 3,000 kg (6,614 lbs) when properly installed.

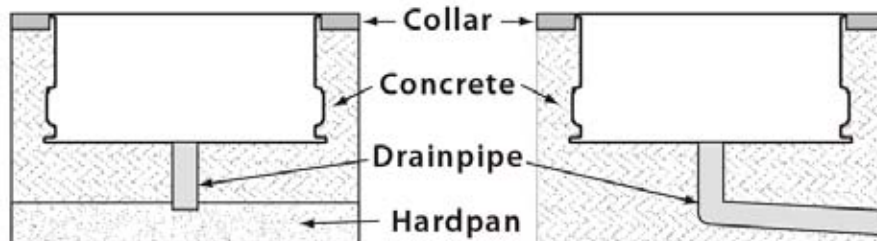

## Beam Angle Adjustment

Illumipod Inground IP products have two LED modules each. You can adjust the angle of each of these modules to spread or narrow the product's beam. Follow these steps:





*Make sure to disconnect the power to the product before opening it.*



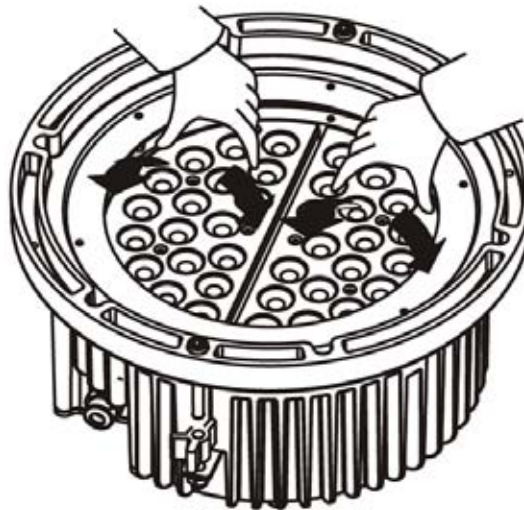

*Be careful when opening and closing the product's housing as it may compromise the product's IP67 rating.*

1. Loosen the Allen bolts on the stainless steel collar by turning no more than a turn or two counter-clockwise to release the aluminum latch from its "locked" position.
2. Lift the product from the installation sleeve, making sure not to stretch the power and signal cables.
3. Loosen four of the six nuts that hold the collar to the housing, leaving untouched any two adjacent nuts.
4. Wait a few seconds for the seal to expand, which lowers the possibility of damaging the seal.
5. Complete the removal of the two remaining nuts.
6. Remove the stainless steel collar.
7. Carefully lift and remove the protective glass and the attached seal, making sure not to reverse the glass.
8. Using only your hands, push on the sides of each module to adjust its angle, as shown in the figure below.
9. Replace the glass and then re-silicone the seal to insure a watertight seal.
10. Replace the stainless steel collar, making sure to align it with the Allen screws while keeping the glass surface flush with the collar.
11. Replace all six nuts and adjust them manually until they touch the housing.
12. Tighten the nuts uniformly by alternating between opposite nuts.
13. Reattach the product to the installation sleeve by turning the Allen bolts clockwise. You should only need a turn or two to have the stainless steel collar firmly attached.



 Make sure to connect the Illumipod Inground IP product to a power line with the proper voltage and frequency, as per the specifications in this manual or on the product's sticker.

 The listed current rating indicates the maximum current draw during normal operation.

 Always connect the Illumipod Inground IP products to protected circuits (CB or fuse) with an appropriate electrical ground to avoid the risk of electrocution or fire.

 Never connect an Illumipod Inground IP product to a rheostat (variable resistor) or dimmer circuit, even if the rheostat or dimmer channel serves only as a 0 to 100% switch.

 Make sure to use power and signal cables with the indicated outer diameters to ensure that the corresponding gland nut makes full contact with the cable's external insulation. This is required to keep the product's IP67 rating when fully adjusted.

## AC Power

### Input Voltage and Frequency

The products in the Illumipod Inground IP Series have an auto-ranging power supply with an input voltage range of 100~240 VAC, 50/60 Hz.

### Power Consumption

To determine the power requirements for any of the Illumipod Inground IP products see the label affixed to the side of the product. Alternatively, you may refer to the corresponding specifications chart in the *Technical Information* chapter of this manual.

## Junction Box Wiring

The Illumipod Inground IP products have an IP67 rated junction box where the power and signal cables come into the unit. The cables access the junction box through individual (signal and power) IP67 rated stainless steel gland nuts.

Make sure that the junction seal is clean before placing the cover back on. In addition, tighten the gland nuts and the junction cover to prevent water from entering the junction box and causing a short.

The figure below shows the connections in the junction box.

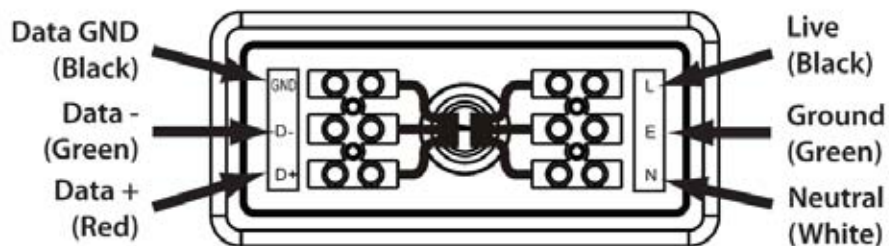

### Power Wiring

To provide AC power for any of the Illumipod Inground IP products, you must run a single SJTW rated 3-conductor cable (AWG18/3, 6~8 mm external diameter) from the power distribution box into the installation sleeve and the product's junction box.

Strip the end of the AC power cable that will connect to the junction box as indicated in the figure on the right.

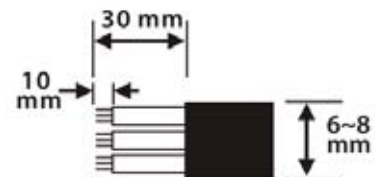

Connection	Wire (US)	Wire (Europe)
Live	Black	Brown
Neutral	White	Blue
Ground	Green/Yellow	Green/Yellow

AC Power Input Wiring

**i** The signal cable must match or exceed the electrical characteristics of the Belden® 9841 cable for EIA RS-485 applications. You can also use CAT 5, CAT 5e, or CAT 6.

### Signal Wiring

To provide signal for any of the Illumipod Inground IP products, you must run a single, IP67 rated DMX signal cable (shielded, 2-conductor, AWG24/2, 6.5 mm external diameter) from the signal distribution box into the installation sleeve and the product's junction box.

### External Wiring

You must run AC power and signal wires from the respective AC and signal distribution boxes into each of the Illumipod Inground IP products.

#### Power Distribution

Connect the bare-ended power cable from the product to a power distribution box as indicated below.

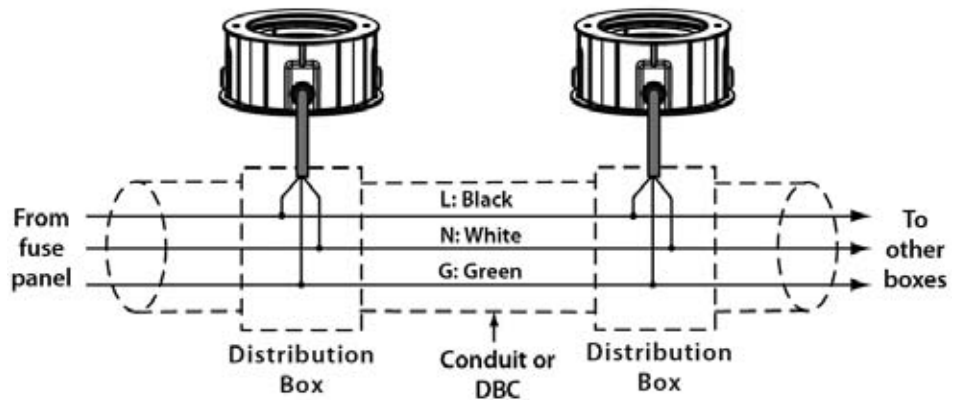

#### Signal Distribution

Connect the bare-ended signal cable from the product to a signal distribution box as indicated below.

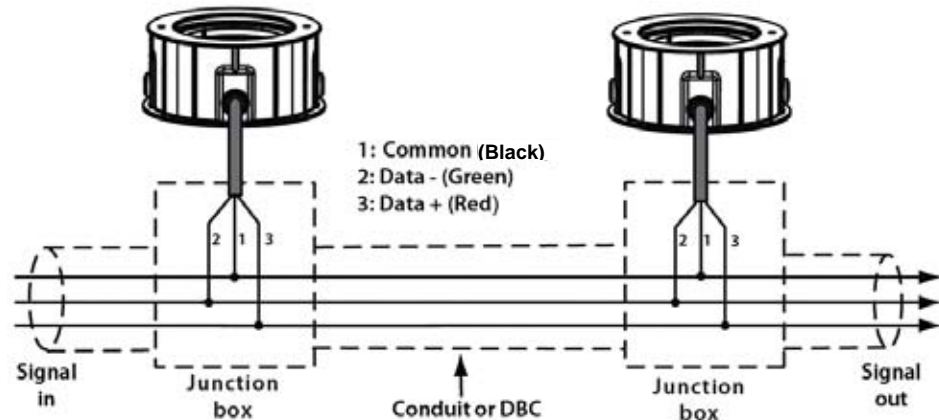

## Controllers

The products in the Ilumipod Inground IP Series can operate with a standard DMX controller, the ILUMICON controller, or the Ilumicode controller. The sections below will show you how to connect these products to the corresponding controllers. The instructions to operate these products with each of the above controllers are in the *Operation* chapter of this manual.

### DMX Controller

The Ilumipod Inground IP products can work with a standard DMX controller. The channel assignments will depend on the selected personality (refer to the *Menu Map* on pages 11 and 12) and the DMX address assigned to each product (refer to *Programming* on page 13).

The figure below illustrates how to connect the DMX controller to the Ilumipod Inground IP products.



If you have not configured the DMX starting address and DMX mode for each product, they will all use their default values. This means that all products will operate in unison.

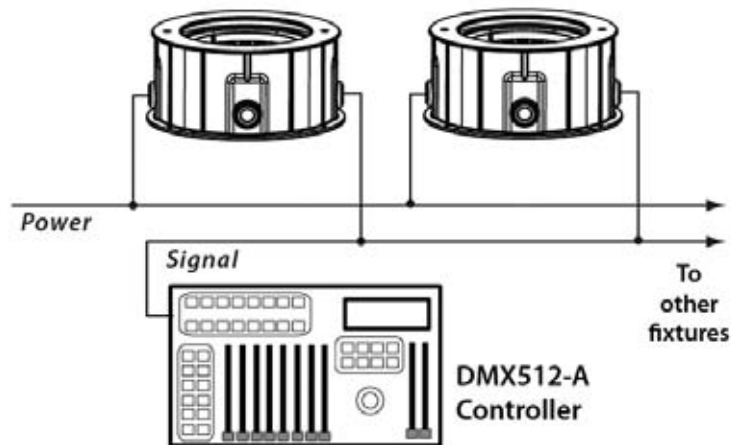

### ILUMICON

The Ilumipod Inground IP products can also work with the ILUMICON controller instead of a standard DMX controller. Please refer to the ILUMICON User Manual to learn how to use this controller with the Ilumipod Inground IP products.

The figure below illustrates how to connect the ILUMICON controller to the Ilumipod Inground IP products.



Refer to the *Operation* chapter to learn how to enable the Ilumipod Inground IP products to operate with the ILUMICON controller.

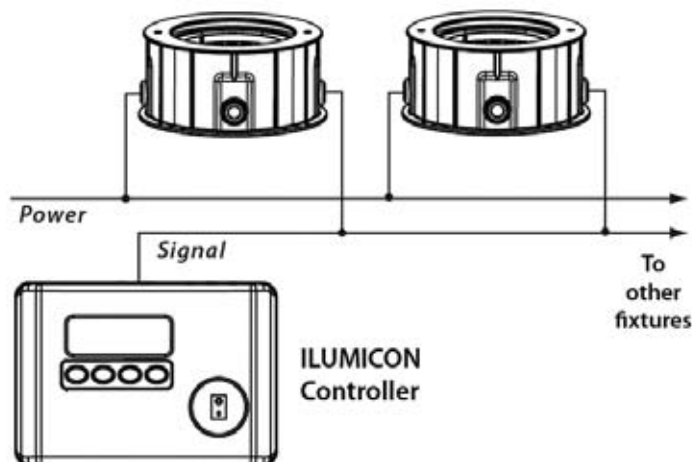

**Ilumicode**

The diagram below shows how to connect the Ilumicode to this product.

Note that this connection will control multiple products at the same time, all having the same DMX address.



To assign individual DMX addresses to each product, you must connect the Ilumicode controller individually to each product.

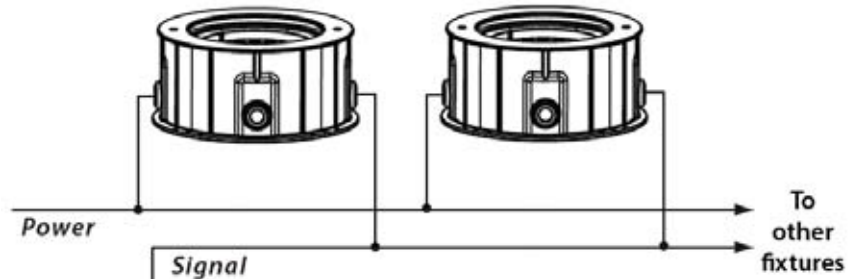

ILUMINARC® suggests that you connect no more than 20 products in this mode and keep the total distance to less than 60 m (197 ft). Otherwise, you might need to use an optically isolated signal amplifier.

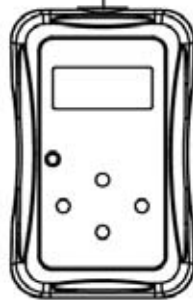

1. Gnd  
2. Data -  
3. Data +  
DMX Output



1. Gnd (Black clip)  
2. Data - (Green clip)  
3. Data + (Red clip)

Signal Connector

## 4. Operation

### Ilumicode

The products in the Ilumipod Inground IP Series lack a control panel. Therefore, they need an external controller, the Ilumicode device, to change their configuration.

#### Ilumicode Panel Description

Button	Function
<MENU>	Exits from the current menu or function
<ENTER>	Enables the currently displayed menu or sets the currently selected value into the selected function
<UP>	Navigates upwards through the menu list and increases the numeric value when in a function
<DOWN>	Navigates downwards through the menu list and decreases the numeric value when in a function
<POWER>	Turns the unit on. The unit will turn off automatically after 30 seconds of inactivity.

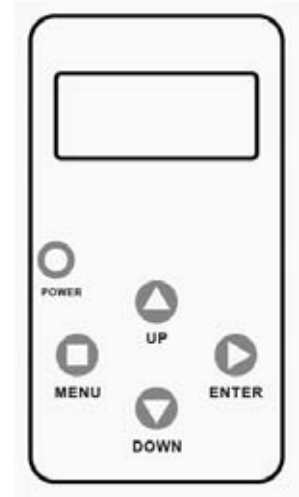

### Menu Map

The products in the Ilumipod Inground IP Series have distinct menu maps based on the colors they produce, whether RGB or White. The Ilumicode controller presents the functions for both types of products.

#### White Functions Menu Map

##### (Ilumipod Inground 36 IP VW)

This menu map shows you which parameters of the Ilumicode controller correspond to the Ilumipod Inground 36 IP VW product.



When you scroll through the menu options, you will see

many of them that do not correspond with this menu map. Skip them, as they do not work with the White output products.

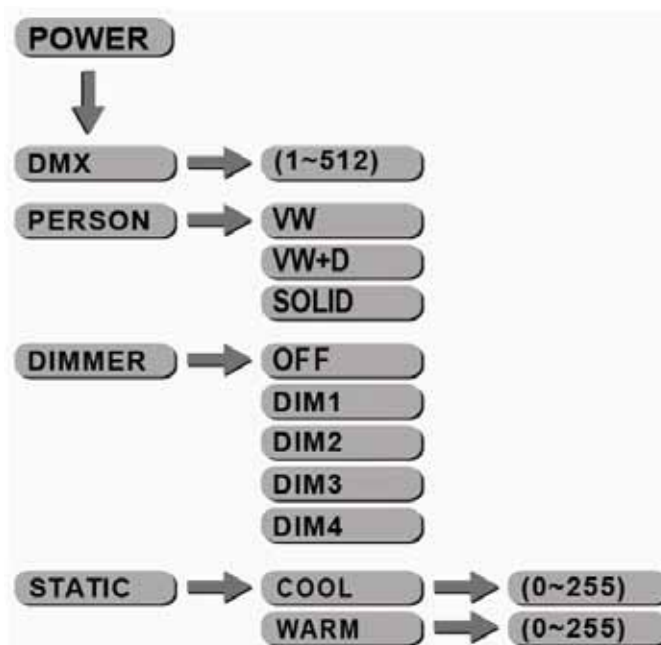

If you scroll after STRB, you will see the RED, GREN, BLUE,

and AMBE colors. Just skip them as they do not work with the VW products.

### RGB Functions Menu Map

(Illumipod Inground 36 IP RGB and Illumipod Inground Tri-12 IP)



When you scroll through the menu options, you will see many of them that do not correspond with this menu map. Skip them, as they do not work with the RGB only output products.

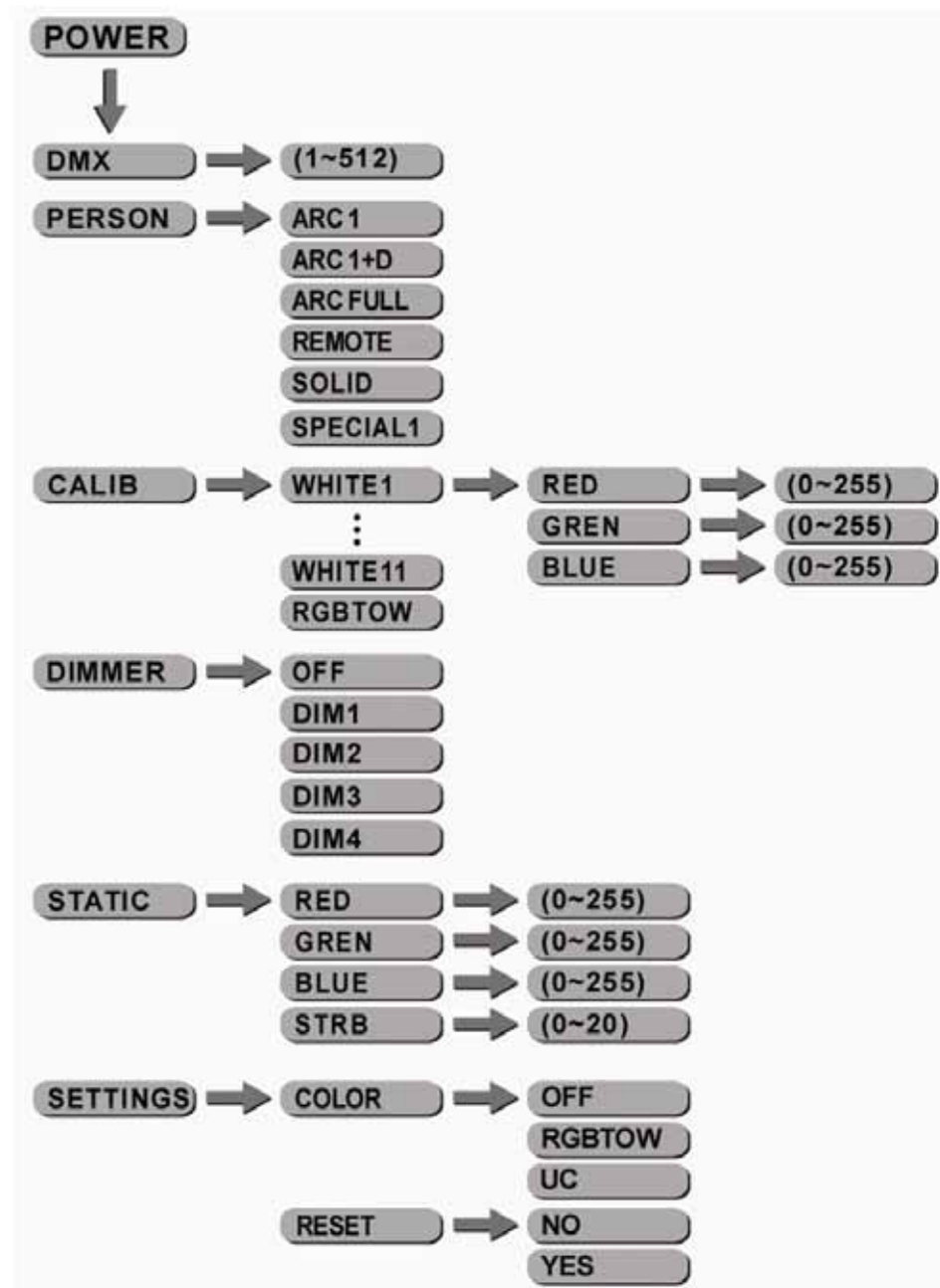

If you scroll after STRB, you will see the AMBE, COOL and WARM colors. Just skip them as they do not work with the RGB products.

## Programming

Carry out all the programming procedures indicated below from Ilumicode's panel. Refer to the corresponding *Menu Map* (pages 11 and 12) to learn how the menu options relate to each other depending on the type of product.



Make sure to press **<ENTER>** after selecting an option. Otherwise, the product will not save the new setting. In this case, the Ilumicode's display will show "SEND..."

Use **<ENTER>** and **<MENU>** to change levels in the *Menu Map*. This is equivalent to moving right and left respectively. Use **<UP>** and **<DOWN>** to move forward and backwards respectively within the *Menu Map* options.

Press **<ENTER>** to accept the selected value for an option. This will send that value to the product(s).

### DMX Personality

(All Ilumipod Inground IP products)

1. Go to **PERSON** and select any DMX personality that matches the product with which you are working (ignore any other options).

36 IP RGB & Tri-12 IP	36 IP VW
ARC1	
ARC+D	
ARC FULL	
SOLID	SOLID
SPECIAL1	
	VW
	VW+D

2. Make sure to arrange the DMX addresses of all products in the current DMX universe to avoid address overlapping.



The DMX Starting Address setting works with all but the **REMOTE** personality.

### DMX Starting Address

(All Ilumipod Inground IP products)

1. Go to **DMX**.
2. Select a starting DMX address (**001~512**).

### Dimmer

(All Ilumipod Inground IP products)

1. Go to **DIMMER**.
2. Select a dimmer curve (**OFF** or **DIM1~4**).

DIMMER	Description
<b>OFF</b>	Dimmer curve is linear with fader
<b>DIM1</b>	Non-linear (fastest)
<b>DIM2</b>	Non-linear (fast)
<b>DIM3</b>	Non-linear (slow)
<b>DIM4</b>	Non-linear (slowest)



Do not connect any other controller to the product(s) when using the ILUMICON controller.

### ILUMICON Control

(Only for 36 IP RGB and Tri-12 IP)

1. Go to **PERSON**.
2. Select the **REMOTE** personality.

### Static Color

(Only for 36 IP RGB and Tri-12 IP)

1. Go to **STATIC**.
2. Select a color (**RED**, **GREEN**, or **BLUE**).
3. Select a color value (**000~255**).
4. Select **STRB**.
5. Select a strobe frequency (**0~20**).

(Only for 36 IP VW)

1. Go to **STATIC**.
2. Select a color (**COOL** or **WARM**).
3. Select a color value (**000~255**).

### Color Calibration

(Only for 36 IP RGB and Tri-12 IP)

1. Go to **CALIB**
2. Select a white color (**WHITE 1~11**) or **RGBTOW**.
3. Select an RGB color (**RED**, **GREEN**, or **BLUE**).
4. Select a color value (**0~255**).
5. Repeat steps **3** and **4** for the other RGB colors to obtain a white color.
6. Repeat steps **2** to **5** for the other white colors.



**WHITE 1~11** define the white color shown when selecting a value **201~255** in channel **5** for the **ARC FULL** personality.



**RGBTOW** defines the white color shown when the **COLOR** value is set to **RGBTOW**.

### Color

(Only for 36 IP RGB and Tri-12 IP)

1. Go to **SETTINGS > COLOR**.
2. Select the color method (**OFF**, **RGBTOW**, or **UC**).

Color	Description
<b>OFF</b>	When the RGB faders are all at “ <b>255</b> ”, the output is at its maximum.
<b>RGBTOW</b>	When the RGB faders are all at “ <b>255</b> ”, the output is the selected white color (see <i>Color Calibration</i> ).
<b>UC</b>	When the RGB faders are all at “ <b>255</b> ”, the output matches the same color output of previous versions of this product.

### Reset

(Only for 36 IP RGB and Tri-12 IP)

1. Go to **SETTINGS > RESET TO FACTORY SETTINGS**.
2. Select an option (**YES/NO**).

## DMX Values

### ARC 1

Channel	Function	Value	Percent/Setting
1	Red	000 ⇔ 255	0 ~ 100%
2	Green	000 ⇔ 255	0 ~ 100%
3	Blue	000 ⇔ 255	0 ~ 100%

### ARC 1 + D

Channel	Function	Value	Percent/Setting
1	Dimmer	000 ⇔ 255	0 ~ 100%
2	Red	000 ⇔ 255	0 ~ 100%
3	Green	000 ⇔ 255	0 ~ 100%
4	Blue	000 ⇔ 255	0 ~ 100%

### ARC FULL

Channel	Function	Value	Percent/Setting
1	Dimmer	000 ⇔ 255	0 ~ 100%
2	Red	000 ⇔ 255	0 ~ 100%
3	Green	000 ⇔ 255	0 ~ 100%
4	Blue	000 ⇔ 255	0 ~ 100%
5	Color Macro + White Balance	000 ⇔ 010	No Function
		011 ⇔ 030	Red 100% - Green Up - Blue 0%
		031 ⇔ 050	Red Down - Green 100% - Blue 0%
		051 ⇔ 070	Red 0% - Green 100% - Blue Up
		071 ⇔ 090	Red 0% - Green Down - Blue 100%
		091 ⇔ 110	Red Up - Green 0% - Blue 100%
		111 ⇔ 130	Red 100% - Green 0% - Blue Down
		131 ⇔ 150	Red 100% - Green Up - Blue Up
		151 ⇔ 170	Red Down - Green Down - Blue 100%
		171 ⇔ 200	Red 100% - Green 100% - Blue 100%
		201 ⇔ 205	White 1: 3,200 K
		206 ⇔ 210	White 2: 3,400 K
		211 ⇔ 215	White 3: 4,200 K
		216 ⇔ 220	White 4: 4,900 K
221 ⇔ 225	White 5: 5,600 K		
226 ⇔ 230	White 6: 5,900 K		
231 ⇔ 235	White 7: 6,500 K		
236 ⇔ 240	White 8: 7,200 K		
241 ⇔ 245	White 9: 8,000 K		
246 ⇔ 250	White 10: 8,500 K		
251 ⇔ 255	White 11: 10,000 K		
6	Strobe	000 ⇔ 004	No Function
		005 ⇔ 255	0 ~ 20 Hz
7	Dimming Speed	000 ⇔ 009	Dimmer is set by Ilumicode
		010 ⇔ 029	OFF (Dimmer is linear)
		030 ⇔ 069	DIM1 (Fastest dimmer curve)
		070 ⇔ 129	DIM2
		130 ⇔ 189	DIM3
		190 ⇔ 255	DIM4 (Slowest dimmer curve)

**SPECIAL 1**

Channel	Function	Value	Percent/Setting
1	Module 1 Red	000 ⇔ 255	0 ~ 100%
2	Module 1 Green	000 ⇔ 255	0 ~ 100%
3	Module 1 Blue	000 ⇔ 255	0 ~ 100%
4	Module 2 Red	000 ⇔ 255	0 ~ 100%
5	Module 2 Green	000 ⇔ 255	0 ~ 100%
6	Module 2 Blue	000 ⇔ 255	0 ~ 100%

**VW**

Channel	Function	Value	Percent/Setting
1	Warm White	000 ⇔ 255	0 ~ 100%
2	Cool White	000 ⇔ 255	0 ~ 100%

**VW + D**

Channel	Function	Value	Percent/Setting
1	Dimmer	000 ⇔ 255	0 ~ 100%
2	Warm White	000 ⇔ 255	0 ~ 100%
3	Cool White	000 ⇔ 255	0 ~ 100%

**SOLID**

Channel	Function	Value	Percent/Setting
1	Dimmer	000 ⇔ 255	0 ~ 100%

## 5. Technical Information

### Product Maintenance

To maintain optimum performance and minimize wear, the user should clean the Ilumipod Inground IP products frequently. Usage and environment are contributing factors in determining the cleaning frequency. As a rule, the user should clean the product at least twice a month. Dust and grime build up on the glass surface reducing light output performance.

To clean an Ilumipod Inground IP product, follow the below recommendations:

1. Disconnect the power to the product.
2. Wait until the product is cold.
3. Loosen the Allen bolts on the stainless steel collar by turning them CCW, not more than a turn or two, enough to release the aluminum latch from its “locked” position.
4. Pull the product out of the installation sleeve, making sure that you are not pulling the signal or AC power cables.
5. Use a wet vacuum cleaner to remove any liquid inside the installation sleeve and around the product’s housing.
6. Inspect the cables and the gland nuts for signs of deterioration.
7. Clean or unclog the water drainage.
8. Replace the product in the installation sleeve.
9. Reattach the product to the installation sleeve by turning the Allen bolts CW. You should only need a turn or two to have the stainless steel collar firmly attached.
10. Clean the glass surface with a mild solution of glass cleaner or isopropyl alcohol, and a soft, lint free cotton cloth or a lens cleaning tissue to remove grease or grime.
11. Apply the solution directly to the cloth or tissue and drag any dirt and grime to the outside of the lens.
12. Gently polish the external glass surface until it is free of haze and lint.



*Always dry the optic surfaces carefully after cleaning them.*



*If you still experience technical problems after trying the solutions in the Troubleshooting Guide, contact ILUMINARC® Technical Support.*

### Product Repairs

ILUMINARC® strongly advises you against attempting any repairs to this product unless you are an authorized ILUMINARC® technician.

ILUMINARC® presents the information contained in the Troubleshooting Table as a guide only. In most cases, opening the product’s housing will invalidate its warranty, unless there is a written indication to the contrary.

## Troubleshooting Guide

Symptom	Cause(s)	Action(s)
Product does not light up	Dimmer fader set to “0”	Increase the value of the dimmer channel
	All color faders set to “0”	Increase the value of the color channels
	All colors in STATIC are set to “0”	Increase the values of the colors
	Unit is being configured with Ilumicode	Complete the configuration process.
	No power	Verify external power circuit and wiring
	Faulty internal power supply	Change power supply
	Faulty main control board	Change main control board
One LEDs does not work	Faulty LED	Change LED module
	Faulty LED module	
	Faulty LED driver	Change LED driver
Two or more LEDs do not work on a single module	Faulty LED module	Change LED module
	Faulty LED driver	Change LED driver
The wrong LEDs light up when using DMX	Wrong personality	Change the personality
	Wrong DMX address	Change the DMX address
Circuit breaker/fuse keeps tripping/blowing	Excessive circuit load	Check total load on electrical circuit
	Short circuit along the power wires	Check for a short in the electrical wiring
Product does not respond to DMX	Wrong DMX addressing	Change DMX address
	Damaged DMX cables	Check DMX cables
	Wrong polarity on the controller	Check polarity switch settings on the controller
	Loose DMX cables	Check cable connections
	Faulty DMX interface	Replace the main control board
	Faulty Display/Main board	
DMX signal problems	Non DMX cables	Use only DMX compatible cables
	Unstable control signals	Install terminator as suggested
	Long cable / low level signal	Install an optically coupled DMX splitter right after the product with the strong signal
	Too many products	Install an optically coupled DMX splitter after unit #32 or before
	Interference from AC wires	Keep DMX cables separated from power cables or fluorescent/black lights

**Exploded View**

Reference	Description
1	Stainless steel cover
2	15 mm tempered glass
3	Diaphragm
4	LED lens panels
5	LED boards
6	Heat sink
7	Power supply
8	Control board
9	Inner housing
10	Installation sleeve
11	Dustproof board

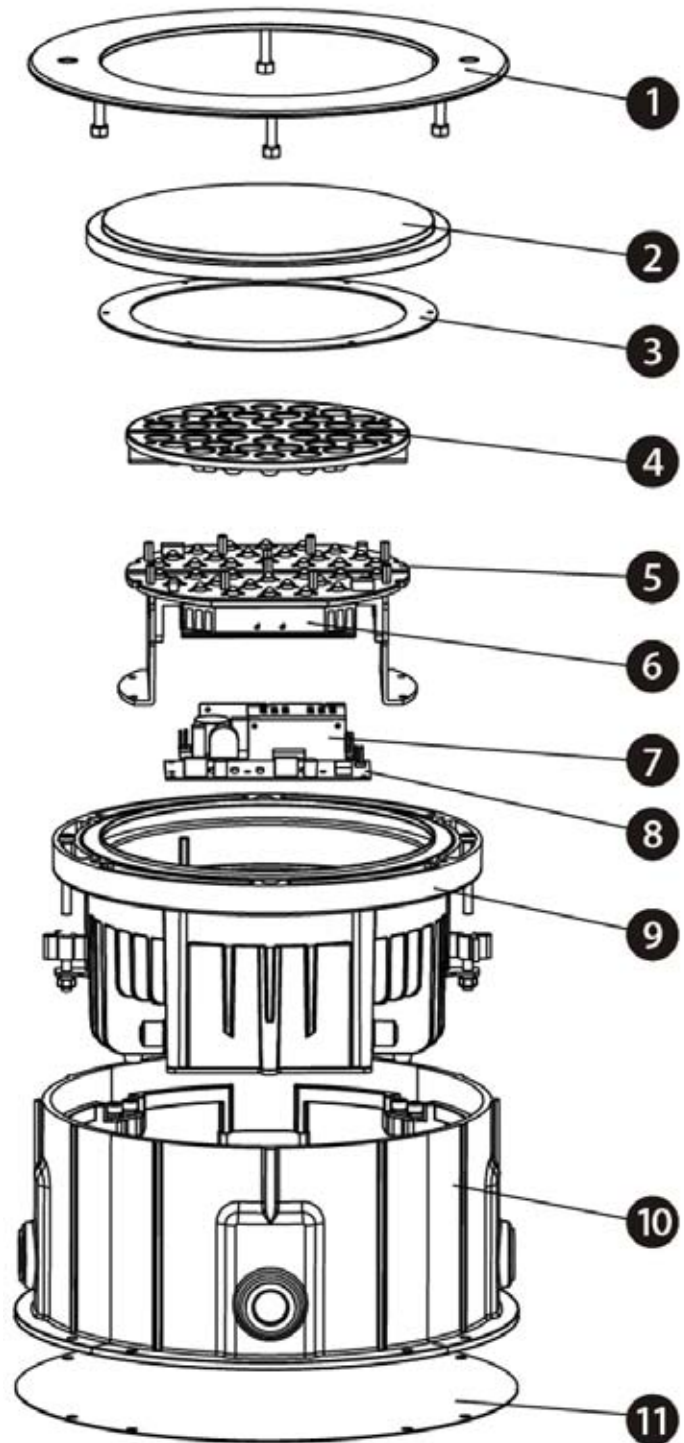

## Photometrics

### *Ilumipod Inground 36 IP 15° VW*

<b>Filename:</b>	Ilumipod Inground 36 IP Optic 15 RGB 100% ALL
<b>Manufacturer:</b>	ILUMINARC
<b>Luminaire:</b>	Ilumipod Inground 36 IP Optic 15 RGB
<b>Lamp:</b>	12 Red, 12 Green, 12 Blue
<b>Lamp Output:</b>	1 lamp(s), rated Lumens/lamp: 1380
<b>Max Candela:</b>	8,753.5 at Horizontal: 180, Vertical: 3
<b>Input Wattage:</b>	43.1
<b>Luminous Opening:</b>	Point
<b>Test:</b>	2009 ALL
<b>Test Lab:</b>	Iluminarc R & D Optics Laboratory
<b>Photometry :</b>	Type B
<b>CIE Class:</b>	Direct
<b>Cutoff Class:</b>	Full Cutoff

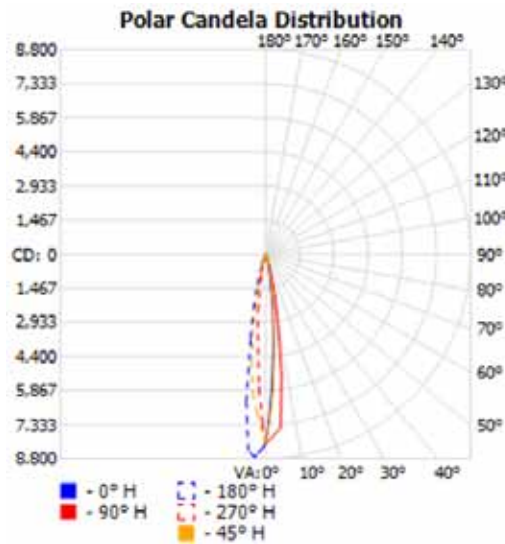

### Flood Summary

	Efficiency	Lumens	Horizontal Spread	Vertical Spread
<b>Field (10%):</b>	40.3%	556.6	28	28
<b>Beam (50%):</b>	17.7%	244.3	13.1	13.4
<b>Total:</b>	55.7%	768.1		

### Illuminance at a Distance

Distance (ft)	Center Beam (fc)	Vertical Beam Width (ft)	Horizontal Beam Width (ft)
3	907.01	0.7	0.7
6	226.75	1.4	1.4
9	100.78	2.1	2.1
12	56.69	2.8	2.8
15	32.28	3.5	3.4
18	25.19	4.2	4.1
<b>Vertical Spread</b>		13.4°	<b>Horizontal Spread</b>
			13.1°



Photometrics  
Pro 1.3.2  
copyright 2003-  
2008 by

jSolutions, Inc.  
Reported data calculated  
from manufacturer's data  
file, based on IES  
recommended methods.

**Illumipod Inground 36 IP 30° VW**

<b>Filename:</b>	Illumipod Inground 36 IP Optic 30 VW 100% ALL
<b>Manufacturer:</b>	ILUMINARC
<b>Luminaire:</b>	Illumipod Inground 36 IP Optic 30 VW
<b>Lamp:</b>	24 Warm White, 12 Cool White
<b>Lamp Output:</b>	1 lamp(s), rated Lumens/lamp: 3000
<b>Max Candela:</b>	3,534.3 at Horizontal: 0, Vertical: 0
<b>Input Wattage:</b>	46.5
<b>Luminous Opening:</b>	Point
<b>Test:</b>	2009 ALL
<b>Test Lab:</b>	Illuminarc R & D Optics Laboratory
<b>Photometry :</b>	Type B
<b>CIE Class:</b>	Direct
<b>Cutoff Class:</b>	Full Cutoff

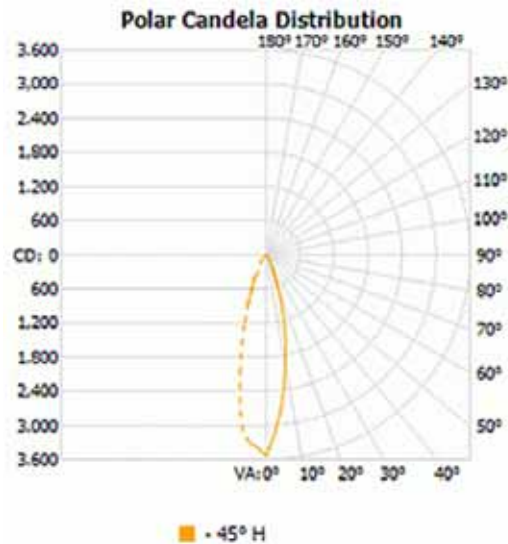

**Flood Summary**

	Efficiency	Lumens	Horizontal Spread	Vertical Spread
<b>Field (10%):</b>	27.3%	819.3	52.2	52.7
<b>Beam (50%):</b>	13.8%	413.5	26.5	26.6
<b>Total:</b>	32.8%	985.2		

**Illuminance at a Distance**

Distance (ft)	Center Beam (fc)	Vertical Beam Width (ft)	Horizontal Beam Width (ft)
3	392.70	1.4	1.4
6	98.18	2.8	2.8
9	43.63	4.2	4.2
12	24.54	5.7	5.6
15	15.71	7.1	7.1
18	10.91	8.5	8.5
<b>Vertical Spread</b>		26.6°	<b>Horizontal Spread</b>
			26.5°



Photometrics  
Pro 1.3.2  
copyright 2003-  
2008 by

jSolutions, Inc.  
Reported data calculated  
from manufacturer's data  
file, based on IES  
recommended methods.

**Illumipod Inground 36 IP 15° RGB**

<b>Filename:</b>	Illumipod Inground 36 IP Optic 15 RGB 100% ALL
<b>Manufacturer:</b>	ILUMINARC
<b>Luminaire:</b>	Illumipod Inground 36 IP Optic 15 RGB
<b>Lamp:</b>	12 Red, 12 Green, 12 Blue
<b>Lamp Output:</b>	1 lamp(s), rated Lumens/lamp: 1380
<b>Max Candela:</b>	8,753.5 at Horizontal: 180, Vertical: 3
<b>Input Wattage:</b>	43.1
<b>Luminous Opening:</b>	Point
<b>Test:</b>	2009 ALL
<b>Test Lab:</b>	Illuminarc R & D Optics Laboratory
<b>Photometry :</b>	Type B
<b>CIE Class:</b>	Direct
<b>Cutoff Class:</b>	Full Cutoff

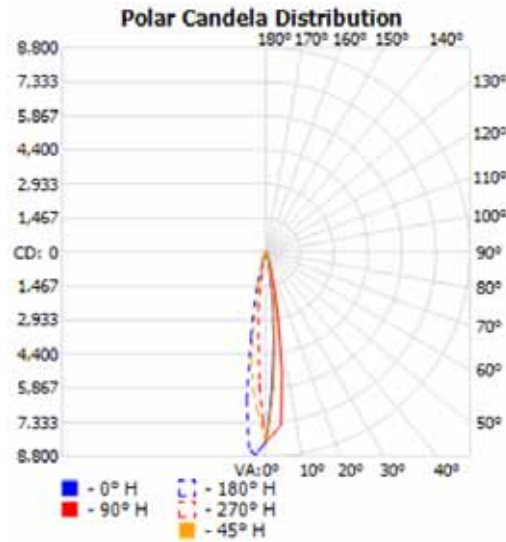

**Flood Summary**

	Efficiency	Lumens	Horizontal Spread	Vertical Spread
<b>Field (10%):</b>	40.3%	556.6	28	28
<b>Beam (50%):</b>	17.7%	244.3	13.1	13.4
<b>Total:</b>	55.7%	768.1		

**Illuminance at a Distance**

Distance (ft)	Center Beam (fc)	Vertical Beam Width (ft)	Horizontal Beam Width (ft)
3	907.01	0.7	0.7
6	226.75	1.4	1.4
9	100.78	2.1	2.1
12	56.69	2.8	2.8
15	36.28	3.5	3.4
18	25.19	4.2	4.1
<b>Vertical Spread</b>		13.4°	<b>Horizontal Spread</b>
			13.1°



Photometrics Pro  
1.3.2 copyright  
2003-2008 by  
jSolutions, Inc.

Reported data calculated  
from manufacturer's data  
file, based on IES  
recommended methods.

**Ilumipod Inground 36 IP 30° RGB**

<b>Filename:</b>	Ilumipod Inground 36 IP Optic 30 RGB 100% ALL
<b>Manufacturer:</b>	ILUMINARC
<b>Luminaire:</b>	Ilumipod Inground 36 IP Optic 30 RGB
<b>Lamp:</b>	12 Red, 12 Green, 12 Blue
<b>Lamp Output:</b>	1 lamp(s), rated Lumens/lamp: 1380
<b>Max Candela:</b>	2,520.5 at Horizontal: 0, Vertical: 3
<b>Input Wattage:</b>	43.3
<b>Luminous Opening:</b>	Point
<b>Test:</b>	2009 ALL
<b>Test Lab:</b>	Iluminarc R & D Optics Laboratory
<b>Photometry :</b>	Type B
<b>CIE Class:</b>	Direct
<b>Cutoff Class:</b>	Full Cutoff

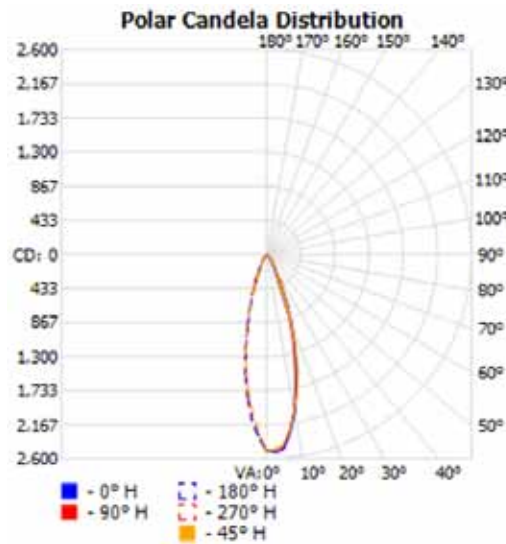

**Flood Summary**

	Efficiency	Lumens	Horizontal Spread	Vertical Spread
<b>Field (10%):</b>	48.7%	672.7	55.4	55.2
<b>Beam (50%):</b>	25.6%	352.8	28.3	28.8
<b>Total:</b>	56.8%	784.4		

**Illuminance at a Distance**

Distance (ft)	Center Beam (fc)	Vertical Beam Width (ft)	Horizontal Beam Width (ft)
3	277.84	1.5	1.5
6	69.46	3.1	3.0
9	30.87	4.6	4.5
12	17.36	6.2	6.0
15	11.11	7.7	7.6
18	7.72	9.3	9.1
<b>Vertical Spread</b>		28.4°	<b>Horizontal Spread</b>
			28.3°



Photometrics Pro 1.3.2  
copyright 2003-2008 by

jSolutions, Inc.  
Reported data calculated from manufacturer's data file, based on IES recommended methods.

**Illumipod Inground Tri-12 IP 16°**

<b>Filename:</b>	Illumipod Inground Tri-12 IP Optic 16 RGB 100% ALL
<b>Manufacturer:</b>	ILUMINARC
<b>Luminaire:</b>	Illumipod Inground Tri-12 IP Optic 16 RGB
<b>Lamp:</b>	12 Tri-color
<b>Lamp Output:</b>	1 lamp(s), rated Lumens/lamp: 1380
<b>Max Candela:</b>	5,633.6 at Horizontal: 0, Vertical: 0
<b>Input Wattage:</b>	17.6
<b>Luminous Opening:</b>	Point
<b>Test:</b>	2009 ALL
<b>Test Lab:</b>	Illuminarc R & D Optics Laboratory
<b>Photometry :</b>	Type B
<b>CIE Class:</b>	Direct
<b>Cutoff Class:</b>	Full Cutoff

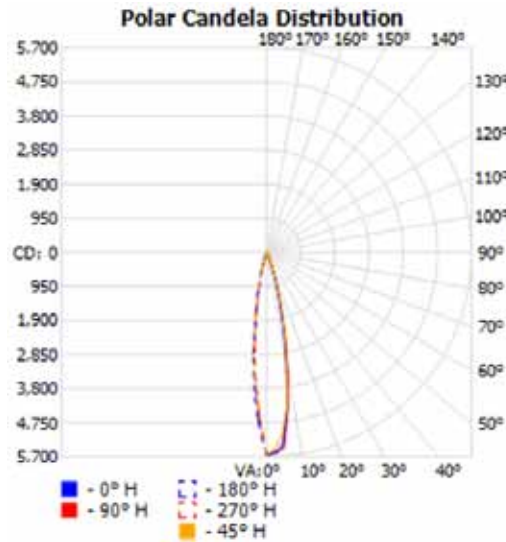

**Flood Summary**

	Efficiency	Lumens	Horizontal Spread	Vertical Spread
<b>Field (10%):</b>	42.2%	583.0	33.7	34.2
<b>Beam (50%):</b>	21.4%	295.3	18.3	18.4
<b>Total:</b>	49.2%	679.1		

**Illuminance at a Distance**

Distance (ft)	Center Beam (fc)	Vertical Beam Width (ft)	Horizontal Beam Width (ft)
3	625.96	1.0	1.0
6	156.49	1.9	1.9
9	69.55	2.9	2.9
12	39.12	3.9	3.9
15	25.04	4.9	4.8
18	17.39	5.8	5.8
<b>Vertical Spread</b>		18.4°	<b>Horizontal Spread</b> 18.3°



Photometrics Pro 1.3.2 copyright 2003-2008 by

jSolutions, Inc. Reported data calculated from manufacturer's data file, based on IES recommended methods.

## LED Disclaimer

### ***LED Life***

ILUMINARC® rates LED lifetime based on lumen depreciation of 70% of the original output, with data provided by the manufacturer of the LED. Data from the manufacturer of the LED are not independently verified or measured by ILUMINARC®. When the product is operating in optimal environmental conditions, the LED lifetime is rated to be 50,000 to 70,000 hours by the LED manufacturer.

### ***LED Binning***

LED manufacturers sort LEDs into “bins”, based on variances in color, output intensity, and the frequency at which the semiconductor operates. ILUMINARC® strives to hold its LED manufacturers to the highest standards of binning to optimize consistency in output from product to product. However, the availability of a single bin cannot be guaranteed. With that in mind, ILUMINARC® has developed a rigorous control system to seek the best achievable consistency in color and output.

### ***Color Rendering Index (CRI)***

CRI is an industry standard method to compare properties of different types of light sources. There are known limitations and inconsistencies related to CRI. Results may vary depending on the environmental factors involved. For this reason, the US Department of Energy (DOE) states that CRI should be considered as one point of reference among others in evaluating white LED products and systems.

The following is an excerpt of recommendations from the DOE:

1. Identify the visual tasks to be performed under the light source. If color fidelity under different light sources is critically important (for example in a space where color or fabric comparisons are made under both daylight and electric lighting), CRI values may be a useful metric for rating LED products.
2. CRI may be compared only for light sources of equal CCT. This applies to all light sources, not only to LEDs. Also, differences in CRI values of less than five points are not significant, e.g., light sources with 80 and 84 CRI are essentially the same.
3. If color appearance is more important than color fidelity, do not exclude white light LEDs solely on the basis of relatively low CRI values. Some LED products with CRIs as low as 25 still produce visually pleasing white light.
4. Evaluate LED systems in person and, if possible, on-site when color fidelity or color appearance are important issues.

Source: DOE publication: PNNL-SA-56891, January 2008

## Returns Procedure

The user must send the merchandise prepaid, in the original box, and with its original packing and accessories. ILUMINARC® will not issue call tags.

Call ILUMINARC® and request a Return Merchandise Authorization Number (RMA #) before shipping the product. Be prepared to provide the model number, serial number, and a brief description of the cause for the return.

The user must clearly label the package with a Return Merchandise Authorization Number (RMA #). ILUMINARC® will refuse any product returned without the RMA #.

Once you receive the RMA #, please include the following information on a piece of paper inside the box:

- Your name
- Your address
- Your phone number
- The RMA #
- A brief description of the problem

Be sure to pack the product properly. Any shipping damage resulting from inadequate packaging will be the customer's responsibility. As a suggestion, proper UPS packing or double-boxing is always a safe method to use.

## Claims

The carrier is responsible for any damage incurred during shipping. Therefore, if the received merchandise appears to have damages caused during shipping, the customer must submit the damage report and any related claims with the carrier, not ILUMINARC®. The customer must submit the report upon reception of the damaged merchandise. Failure to do so in a timely manner may invalidate the customer's claim with the carrier.

For other issues such as missing components or parts, damage not related to shipping, or concealed damage, the customer must make claims to ILUMINARC® within seven (7) days of receiving the merchandise.

## Contact Us

### World Wide

#### General Information

ILUMINARC®  
 5200 NW 108th Avenue  
 Sunrise, FL 33351  
 Voice: (954) 923-3680  
 Fax: (954) 929-5571  
 Email: info@iluminarc.com

#### Customer Support

Voice: (954) 923-3680 (ext. 4000)  
 Fax: (954) 756-8015  
 Email: tech@iluminarc.com

#### World Wide Web

www.iluminarc.com



*DO NOT write the RMA # directly on the box. Instead,*

*write it on a properly affixed label.*



*ILUMINARC® reserves the right to use its own discretion to*

*repair or replace returned product(s).*



*Always keep the original box and all packaging material as you*

*will need those to ship the unit back to ILUMINARC®.*

## Technical Specifications

### *Illumipod Inground 36 IP VW*

#### Weight & Dimensions

Diameter ..... 12.6 in (320 mm)  
 Height ..... 5.7 in (146 mm)  
 Weight ..... 17.6 lbs (8 kg)

#### Power

Auto-ranging ..... 100~240 VAC, 50/60 Hz  
 Power consumption @ 120 V ..... 38 W (0.6 A)  
 Power consumption @ 230 V ..... 40 W (0.3 A)  
 Inrush current ..... 0.1 A @ 120 V, 0.3 A @ 230 V  
 Power connectors ..... Terminal strip in sealed junction box

#### Light Source

Type ..... 1 W, 350 mA 50,000 hrs LEDs  
 Configuration ..... 36 LEDs (12 Cool White and 24 Warm White)

#### Construction

Housing ..... Cast aluminum body and stainless steel outer ring  
 Color ..... Black body and silver outer ring  
 Lens cover ..... Impact resistant (drive over rated)  
 Ingress protection (IP) rating ..... IP67

#### Photometrics

Installed optics: ..... 15°  
 Beam angle: ..... 13.1°  
 Field angle: ..... 28.0°  
 Illuminance: ..... 226.75 fc @ 6 ft

#### Thermal

Maximum ambient temperature ..... 104° F (40° C)  
 Cooling ..... Natural convection

#### Control & Programming

Addresser ..... Ilumicode  
 Data input ..... Terminal strip in sealed junction box  
 Data pin configuration ..... Pin 1 shield, pin 2 (-), pin 3 (+)  
 Protocols ..... USITT DMX512-A  
 DMX Channels ..... 1, 2, or 3

#### Ordering Information

Illumipod Inground 36 IP Optic 15° VW ..... 11036010  
 Illumipod Inground 36 IP Optic 30° VW ..... 11036008

#### Warranty Information

Warranty ..... 2-year limited warranty



**Illumipod Inground 36 IP RGB**

**Weight & Dimensions**

Diameter ..... 12.6 in (320 mm)  
 Height ..... 5.7 in (146 mm)  
 Weight ..... 17.6 lbs (8 kg)

**Power**

Auto-ranging ..... 100~240 VAC, 50/60 Hz  
 Power consumption @ 120 V ..... 38 W (0.6 A)  
 Power consumption @ 230 V ..... 40 W (0.3 A)  
 Inrush current ..... 0.1 A @ 120 V, 0.3 A @ 230 V  
 Power connectors ..... Terminal strip in sealed junction box

**Light Source**

Type ..... 1 W, 350 mA 50,000 hrs LEDs  
 Configuration ..... 36 LEDs (12 Red, 12 Green, and 12 Blue)

**Construction**

Housing ..... Cast aluminum body and stainless steel outer ring  
 Color ..... Black body and silver outer ring  
 Lens cover ..... Impact resistant (drive over rated)  
 Ingress protection (IP) rating ..... IP67

**Photometrics**

Installed optics: ..... 15°  
 Beam angle: ..... 13.1°  
 Field angle: ..... 40.3°  
 Illuminance: ..... 226.75 fc @ 6 ft

**Thermal**

Maximum ambient temperature ..... 104° F (40° C)  
 Cooling ..... Natural convection

**Control & Programming**

Addresser ..... Ilumicode  
 Data input ..... Terminal strip in sealed junction box  
 Data pin configuration ..... Pin 1 shield, pin 2 (-), pin 3 (+)  
 Protocols ..... USITT DMX512-A  
 DMX Channels ..... 1, 3, 4, 6, or 7

**Ordering Information**

Illumipod Inground 36 IP Optic 15° RGB ..... 11036009  
 Illumipod Inground 36 IP Optic 30° RGB ..... 11036007

**Warranty Information**

Warranty ..... 2-year limited warranty



**Illumipod Inground Tri-12 IP**

**Weight & Dimensions**

Diameter ..... 12.6 in (320 mm)  
 Height ..... 5.7 in (146 mm)  
 Weight ..... 17.6 lbs (8 kg)

**Power**

Auto-ranging ..... 100~240 VAC, 50/60 Hz  
 Power consumption @ 120 V ..... 38 W (0.6 A)  
 Power consumption @ 230 V ..... 40 W (0.3 A)  
 Inrush current ..... 0.1 A @ 120 V, 0.3 A @ 230 V  
 Power connectors ..... Terminal strip in sealed junction box

**Light Source**

Type ..... 3 W, 1,050 mA 50,000 hrs Tri-color LEDs  
 Configuration ..... 12 Tri-color LEDs

**Construction**

Housing ..... Cast aluminum body and stainless steel outer ring  
 Color ..... Black body and silver outer ring  
 Lens cover ..... Impact resistant (drive over rated)  
 Ingress protection (IP) rating ..... IP67

**Photometrics**

Installed optics: ..... 16°  
 Beam angle: ..... 18.3°  
 Field angle: ..... 33.7°  
 Illuminance: ..... 156.49 fc @ 6 ft

**Thermal**

Maximum ambient temperature ..... 104° F (40° C)  
 Cooling ..... Natural convection

**Control & Programming**

Addresser ..... Ilumicode  
 Data input ..... Terminal strip in sealed junction box  
 Data pin configuration ..... Pin 1 shield, pin 2 (-), pin 3 (+)  
 Protocols ..... USITT DMX512-A  
 DMX Channels ..... 1, 3, 4, 6, or 7

**Ordering Information**

Illumipod Inground Tri-12 IP Optic 15° ..... 11012001

**Warranty Information**

Warranty ..... 2-year limited warranty



---

**ILUMINARC®**  
5200 NW 108<sup>th</sup> Avenue  
Sunrise, FL 33351 U.S.A.  
Tel.: (954) 929-1115  
FAX: (954) 929-5560  
[www.iluminarc.com](http://www.iluminarc.com)

Ilumipod Inground IP Series User Manual Rev. 02  
August 2011

**ILUMINARC®**