

LOGIC™ 1X36

User Manual

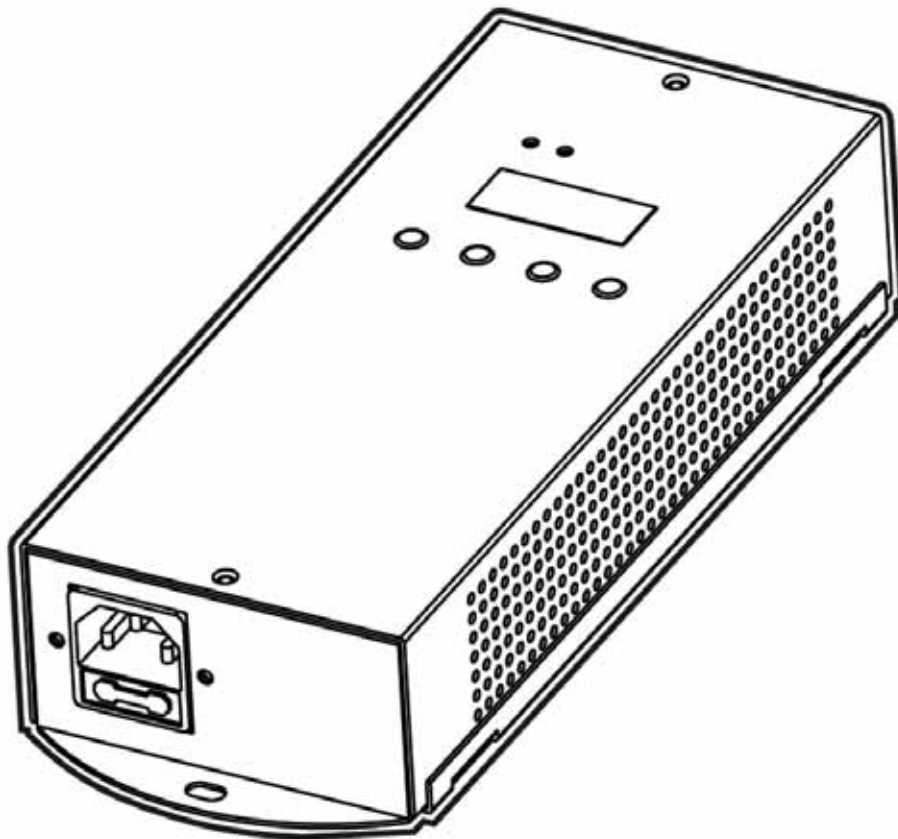

Edition Notes

The LOGIC™ 1X36 User Manual Rev. 07 covers the description, safety precautions, installation, programming, operation, and maintenance of the LOGIC™ 1X36. ILUMINARC® released this edition of the LOGIC™ 1X36 User Manual Rev. 07 in August 2011.

Trademarks

The ILUMINARC® logo, the ILUMINARC® name, and all other trademarks in this document related to services or products by ILUMINARC® are trademarks owned or licensed by ILUMINARC®, its affiliates, or subsidiaries. Any other product names, logos, brands, company names, or trademarks featured or referred to within this document are the property of their respective trademark holders.

Copyright Notice

The entire content of this document, except where applicable and unless otherwise noted, is solely owned by ILUMINARC®, a wholly owned trademark of CHAUVET & Sons Inc.

© Copyright 2011 ILUMINARC®

All rights reserved.

Electronically published by ILUMINARC® in the United States of America.

Manual Usage

ILUMINARC® authorizes its customers to download and print this manual for professional information purposes only. ILUMINARC® expressly prohibits the usage, copy, storage, distribution, modification, or printing of this manual or its content for any other purpose without its written consent.

Document Printing

For better results, print this document in color, on letter size paper (8.5 x 11 inches), double sided. If using A4 paper (210 x 297 mm), configure your printer to scale the content of this document to A4 paper.

Intended Audience

Any person in charge of installing, operating, and/or maintaining the LOGIC™ 1X36 should read the Guide that shipped with it and this manual in their entirety before installing, operating, or maintaining this product.

Disclaimer

ILUMINARC® believes that the information contained in this manual is accurate in all respects. However, ILUMINARC® assumes no responsibility for any error or omissions in this document. ILUMINARC® reserves the right to revise this document and to make changes from time to time in the content hereof without obligation of ILUMINARC® to notify any person or company of such revision or changes. This does not constitute in any way a commitment by ILUMINARC® to make such changes. ILUMINARC® may issue a revision of this manual or a new edition of it to incorporate such changes.

Document Revision

The LOGIC™ 1X36 User Manual Rev. 07 supersedes all previous versions of this manual. Please discard any older versions of this manual you may have, whether in printed or electronic format, and replace them with this version.

Table of Contents

- 1. Introduction.....1**
 - What is Included..... 1
 - Unpacking Instructions..... 1
 - Text Conventions 1
 - Safety Notes..... 2
 - Personal Safety2
 - Mounting and Installation.....2
 - Power and Wiring2
 - Operation.....2
- 2. Product Description3**
 - Features 3
 - Additional Features.....3
 - Product Overview 4
- 3. Installation5**
 - AC Power 5
 - Power Consumption5
 - AC Plug5
 - Fuse Replacement5
 - DMX Linking..... 6
 - DMX Modes.....6
 - Master/Slave Linking 6
 - LQIC™ 1X36 Product Linking 7
 - Maximum Output Line Loading 8
 - Cable Connections 9
 - Mounting..... 10
 - Orientation10
 - Installation10
 - Procedure10
- 4. Operation.....11**
 - Control Panel Description..... 11
 - Control Options 11
 - Programming (RGB Mode)..... 11
 - Mode Selection.....11
 - DMX Addressing.....11
 - DMX Personality.....11
 - Master/Slave.....12
 - Static Colors12
 - Auto Play12
 - Custom Play12
 - Edit Custom12
 - RGB to W Setting13
 - Whites Setting13
 - Set Time and Date.....13
 - Set Schedule13
 - Playing Schedule.....13
 - Password.....14
 - Upload Customs14
 - Reset.....14
 - Programming (SpectraWhite™ Mode) 15
 - Mode Selection.....15
 - DMX Addressing.....15
 - DMX Personality.....15
 - Master/Slave.....16
 - Static Colors16
 - Auto Play16

Whites Setting	16
Set Time and Date.....	16
Set Schedule	16
Playing Schedule.....	16
Password.....	17
Reset	17
Menu Options RGB Mode	18
Menu Options SpectraWhite™ Mode.....	20
DMX Values RGB Mode.....	21
EFFECT	21
DMX Values RGB Mode (Cont.)	22
RGB.....	22
RGB + D.....	22
RGB + DMS.....	22
SOLID.....	22
DMX Values SpectraWhite™ Mode	23
STUD W	23
STUD W+D.....	23
STUD 1.....	23
STUD 2.....	23
SOLID.....	23
5. Technical Information	24
System Maintenance.....	24
Product Repairs.....	24
Troubleshooting Guide	25
LED Disclaimer.....	26
LED Life.....	26
LED Binning.....	26
Color Rendering Index (CRI).....	26
Returns Procedure	27
Claims.....	27
Contact Us.....	27
Technical Specifications.....	28

1. Introduction



This icon indicates useful, although non-critical information.



This icon indicates important installation or configuration information. Failure to comply with this information may prevent the product from functioning correctly.



This icon indicates critical installation, configuration, or operation information. Failure to comply with this information may render the product partially or completely inoperative, damage third-party equipment, or cause harm to the user.



The term “DMX” used throughout this document refers to the USITT DMX512-A transmission protocol.

What is Included

- One LQIC™ 1X36
- One RJ-45 to 3-pin DMX male adapter (input)
- One RJ-45 to 3-pin DMX female adapter (output)
- One RJ-45 coupler
- One Power Cord
- Warranty Card
- Quick Start Guide

Unpacking Instructions

Immediately upon receiving a product from ILUMINARC®, carefully unpack the carton. Check the contents of the box to ensure that all parts are present and that they are in good condition. If any part appears damaged from shipping, or if the carton shows signs of mishandling, see the Claims section in the Technical Information chapter.

Text Conventions

Convention	Meaning
1~512	A range of values in the text
50/60	A set of mutually exclusive values in the text
“ILUMICON UM”	The name of another publication or manual
<SET>	A button on the product’s control panel
Settings	A product function or a menu option
MENU > Settings	A sequence of menu options
1~10	A range of menu values from which to choose in a menu
Yes/No	A set of two mutually exclusive menu options in a menu
ON	A unique value to enter or select in a menu



There are no user serviceable parts inside this product. Any reference to servicing it you may find from now on in this User Manual will only apply to properly ILUMINARC® certified technicians. Do not open the housing or attempt any repairs unless you are certified to do so.



Please refer to all applicable local codes and regulations for the proper installation of this product.



Keep this manual for future consultation. If you sell this product to another user, make sure that they also receive this manual.



In the unlikely event that your LQGIC™ 1X36 may require service, please contact ILUMINARC® Technical Support.

Safety Notes

Please read all the following safety notes carefully because they include important information on how to install, use, and maintain this product safely.

Personal Safety

- Avoid direct eye exposure to the light source while the product is on.
- Always disconnect this product from its power source before servicing.
- Always connect this product to a grounded circuit to avoid the risk of electrocution.

Mounting and Installation

- This product is for indoor use only! To prevent risk of fire or shock, do not expose this product to rain or moisture.
- Make sure there are no flammable materials close to this product while operating.
- When hanging this product, always secure it to a fastening device using a safety cable (not provided).

Power and Wiring

- Always make sure that you are connecting this product to the proper voltage, as per the specifications in this manual or on the product's sticker.
- Never connect this product to a dimmer pack.
- Make sure that the power input cable is not cracked, crimped, or damaged.
- Never disconnect this product by pulling or tugging on the power input cable.

Operation

- The maximum ambient temperature (T_a) is 104° F (40° C). Do not operate this product at a higher temperature.
- In case of a serious operating problem, stop using this product immediately!

2. Product Description

The LQGIC™ 1X36 product is the power supply and control for the LQGIC™ series of devices. The LQGIC™ 1X36 consists of five personalities for the RGB mode and five personalities for the SpectraWhite™ mode, all of which are configurable from the control panel. The output of the LQGIC™ 1X36 is a RJ-45 type connection. The DMX input and output is on the rear panel and also uses a RJ-45 type connection.

Features

- 1, 2, 3, 4, 5, 6, or 8-channel DMX control
- Operating modes:

RGB

1-channel: RGB, dimmer (no individual RGB adjustments)

3-channel: RGB control (individual RGB adjustments)

4-channel: RGB control, dimmer

6-channel: RGB control, dimmer, color macro, strobe

8-channel: RGB control, dimmer, color macro, strobe, auto + custom, auto speed

SpectraWhite™

1-channel: White dimmer

2-channel: White control (warm + cool)

2-channel: White macro, dimmer

3-channel: White control (warm + cool), dimmer

5-channel: White control (warm + cool), macro, dimmer, strobe

- RGB color mixing with or without DMX control (RGB mode)
- White effects mixing with or without DMX control (SpectraWhite™ mode)
- Automated and customizable programs (RGB mode)
- Recall auto and custom programs via master/slave or DMX

Additional Features

- Master/Slave (RJ-45)
- Static Playing
- RGB and white color calibration
- Schedule playback with time clock functions
- LCD display with password protection

Product Overview

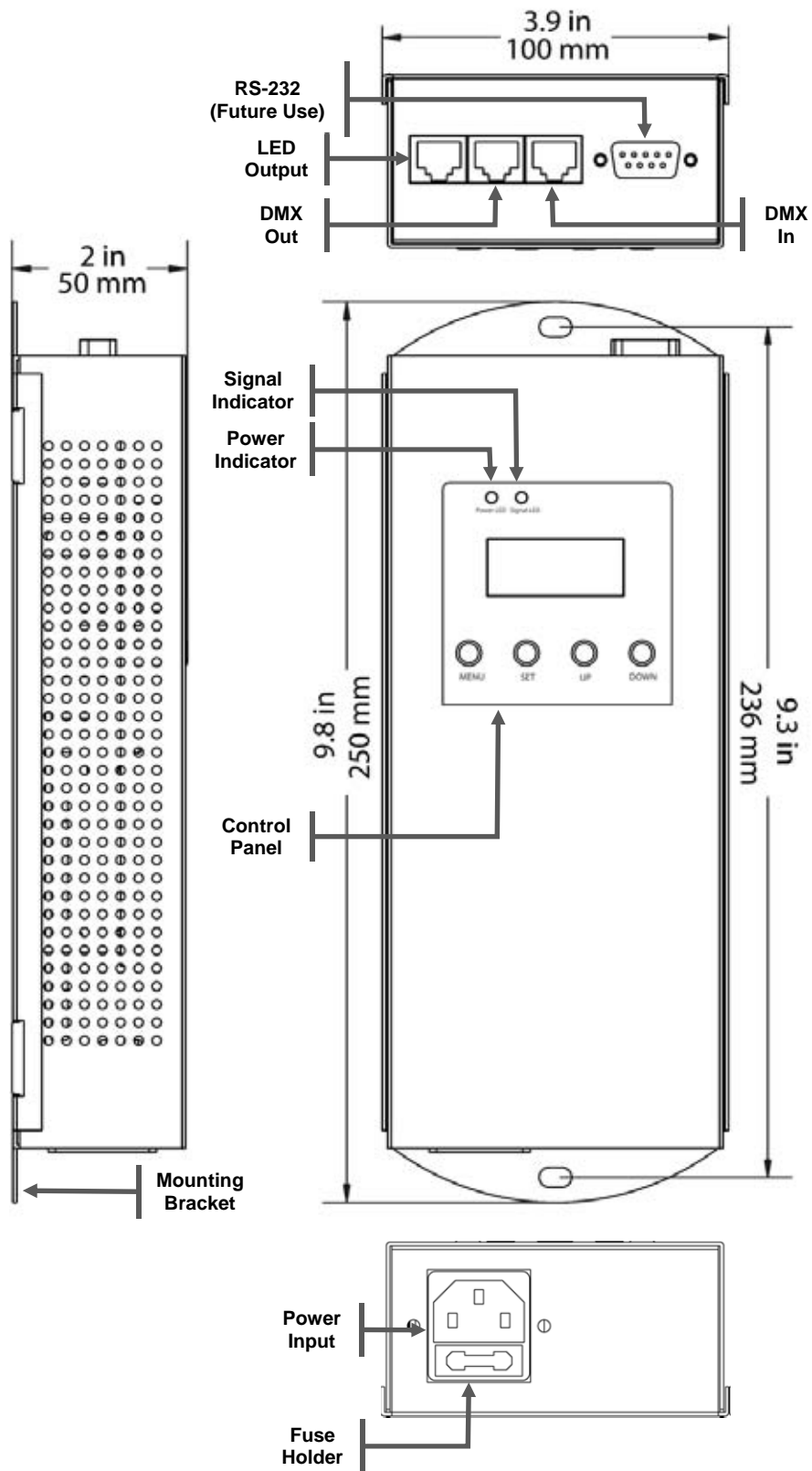

3. Installation



Always connect the LQGIC™ 1X36 to a protected circuit with an appropriate electrical ground to avoid the risk of electrocution or fire.



Never connect the LQGIC™ 1X36 to a rheostat (variable resistor) or dimmer circuit, even if the rheostat or dimmer channel serves only as a 0 to 100% switch.



Make sure to disconnect the products power cord before replacing a blown fuse, and always replace it with a fuse of the same type and rating.

AC Power

The LQGIC™ 1X36 has an auto-ranging power supply that can work with an input voltage range of 100~240 VAC, 50/60 Hz.

Make sure that you are connecting this product to the proper voltage, as per the specifications in this guide, the product’s user manual, or on the product’s sticker.

Power Consumption

To determine the power requirements for the LQGIC™ 1X36 see the label affixed to the side of the product. Alternatively, you may refer to the corresponding specifications chart in the *Technical Information* chapter of this manual.

The listed current rating indicates the maximum current draw during normal operation.

AC Plug

The LQGIC™ 1X36 comes with a power input cord terminated with an IEC connector on one end and an Edison plug on the other end (US market). If the power cord that came with your product has no plug or you need to change the Edison plug, use the table below to wire the new plug.

Connection	Wire (US)	Screw Color (US)	Wire (Europe)
AC Live	Black	Yellow or Brass	Brown
AC Neutral	White	Silver or Gray	Blue
AC Ground	Green/Yellow	Green	Green/Yellow

Fuse Replacement

1. With a flat head screwdriver, wedge the fuse holder out of its housing and remove the blown fuse from its holder.
2. Replace the blown fuse with a fuse of the exact same type and rating.
3. Insert the fuse holder back in its place, and reconnect power.

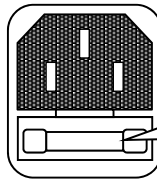

The fuse is located inside this compartment. Remove it using a flat head screwdriver.



The products must be linked using DMX cable

in a daisy chain (serial) fashion. To comply with the EIA-485 standard, no more than 32 products should be connected on one daisy chain without using a DMX optically-isolated splitter. Doing otherwise may result in deterioration of the digital DMX signal.



USITT recommends limiting the total length of the DMX cable (from the first product/controller to the last product) to 300 ~ 455 m (985 ~ 1,500 ft).



The Operation chapter of this manual provides detailed instructions on how to configure the Master and Slave products.

DMX Linking

The LQIGIC™ 4X36 uses a CAT5 cable to link to other units.

- The first unit of each set of LQIGIC™ 4X36 units must connect to the DMX controller with a CAT5 to XLR male adapter.
- The last LQIGIC™ 4X36 unit must use a CAT5 to XLR female adapter to continue the serial link to other DMX compatible units.

You may link the LQIGIC™ 1X36 to a DMX controller using a CAT5. If using other DMX compatible products with the LQIGIC™ 1X36, you can control each individually with a single DMX controller.

It is also possible to run several DMX compatible products synchronized without a DMX controller in a master/slave operating mode. The LQIGIC™ 1X36 supports the master/slave mode.

If you are not familiar with the DMX standard, or if you need information about the DMX cables needed to link the LQIGIC™ 1X36 to a DMX controller, you may download the “DMX Primer” document from the ILUMINARC® web site: www.iluminarc.com

DMX Modes

The LQIGIC™ 1X36 uses the CAT5 DMX data connection for its two DMX modes (SpectraWhite™ and RGB). These modes contain their own separate personalities. Please refer to the Introduction chapter for a brief description of these modes and the Operation Instructions chapter to learn how to configure the LQIGIC™ 1X36 to work in these modes. The DMX Values section will give you detailed information regarding the above-mentioned DMX modes.

Master/Slave Linking

The Master/Slave mode allows a LQIGIC™ 1X36 product (the master) running a preconfigured program to control several other LQIGIC™ 1X36 products (the slaves) without requiring a DMX controller. In this mode, all the slave products will operate in unison with the master product.

When in Master/Slave mode, the LQIGIC™ 1X36 products link to each other using the standard CAT5 DMX connection.

LOGIC™ 1X36 Product Linking

Use this method when connecting a set of one or more LOGIC™ 1X36 products to the same DMX cable. This is the simplest method to connect multiple products to the same DMX controller.

1. Connect the RJ-45 plug of the DMX to RJ-45 adapter to the “DMX In” RJ-45 jack on the first LOGIC™ 1X36 product.
2. Connect the XLR male connector of the DMX to RJ-45 adapter directly to the “DMX Out” (female) connector on the DMX controller or to the DMX cable coming from the DMX controller.
3. Connect one of the RJ-45 plugs of the signal patch cable to the “DMX Out” RJ-45 jack on the first LOGIC™ 1X36 product.
4. Connect the other RJ-45 plug of the signal patch cable to the “DMX In” RJ-45 jack on the second LOGIC™ 1X36 product.
5. Continue linking the LOGIC™ 1X36 products using more signal patch cables, as shown in the diagram below.



Do not use the splitter as a coupler.

ILUMINARC recommends using a signal terminator after the last LOGIC™ 1X36 product. The easiest way to assemble a signal terminator is by soldering or crimping a 120 ohms resistor between the terminals corresponding to DATA + and DATA - on a RJ-45 jack. Another method consists in soldering the 120 ohms resistor to a short cable coming out of a RJ-45 plug. Once assembled, connect the terminator to the “DMX Out” connector of the last LOGIC™ 1X36 product.

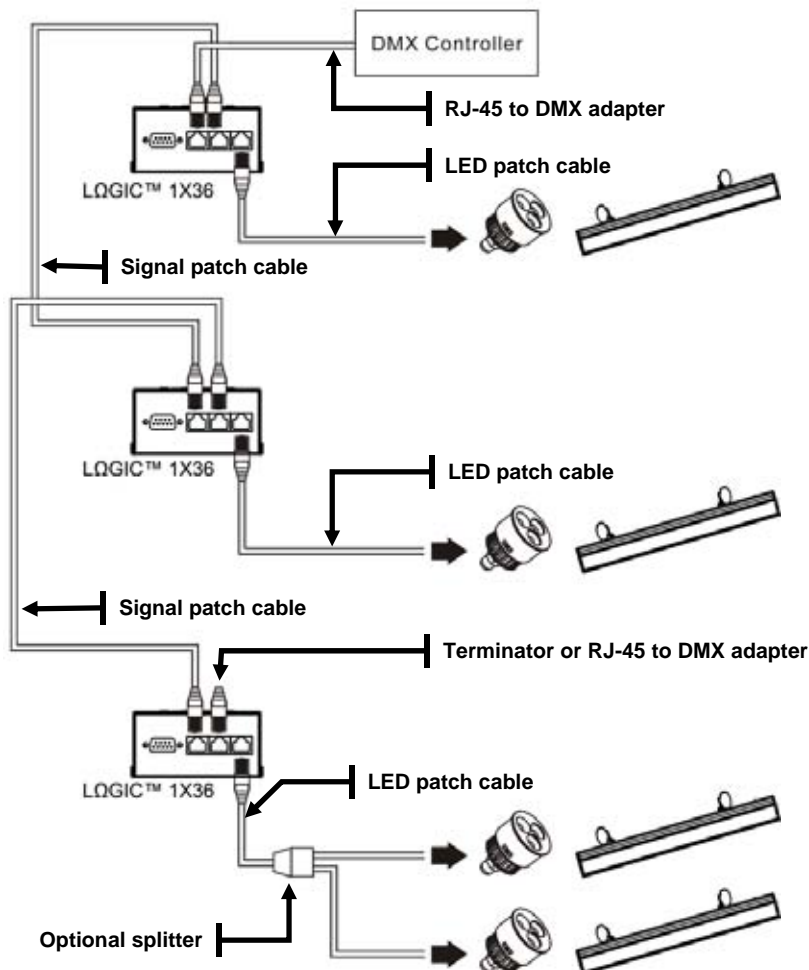

Maximum Output Line Loading

The LQGIC™ 1X36 product has a single output line. The single output line has three channels whose names change depending on the selected operation mode. (Red, Green, and Blue in the RGB mode, or Warm, Natural, and Cool in the SpectraWhite™ mode). Each channel can support up to 12 LEDs. This means that the maximum number of LEDs supported by the output line is 36.



When connecting LQGIC™ devices to the LQGIC™ 1X36 controller, do not exceed the maximum of 12 LEDs per output channel (36 LEDs total for the output line).

Inside the LQGIC™ devices, the LEDs are grouped in clusters of three LEDs each. In an LED cluster, each LED connects to an individual output channel from the LQGIC™ product. When a device has more than one cluster, the same output channel supports as many LEDs as clusters the device has.

Please see the guide below for the output line loading. This table shows the maximum number of a single type of devices that can be loaded onto the LQGIC™ 1X36's output line.

MODEL NAME	TOTAL LED'S	MAX. NUMBER OF CONNECTED PRODUCTS
Illumiline LQGIC™ 36 RGB	36	1
Illumiline LQGIC™ 24 RGB	24	1
Illumiline LQGIC™ 24 Optic RGB	24	1
Illumiline LQGIC™ 12 Optic	12	3
Illumiline LQGIC™ 12	12	3
Illumipod LQGIC™ 12 Optic	12	3
Illumipod LQGIC™ Tri-4	12	3
Illumipod LQGIC™ 6 Optic	6	6
Illumipod LQGIC™ 3 Optic	3	12
Illumipod LQGIC™ Tri-1	3	12

You may also combine different devices together, as long as you do not exceed the maximum of 36 LEDs for the output line. Please see the following example of a possible combination.

Illumipod LQGIC™ Tri-4	12 X 2 = 24	2 products
Illumipod LQGIC™ 6 Optic	6 x 2 = 12	2 products
Total	36 LEDs	4 products

Cable Connections

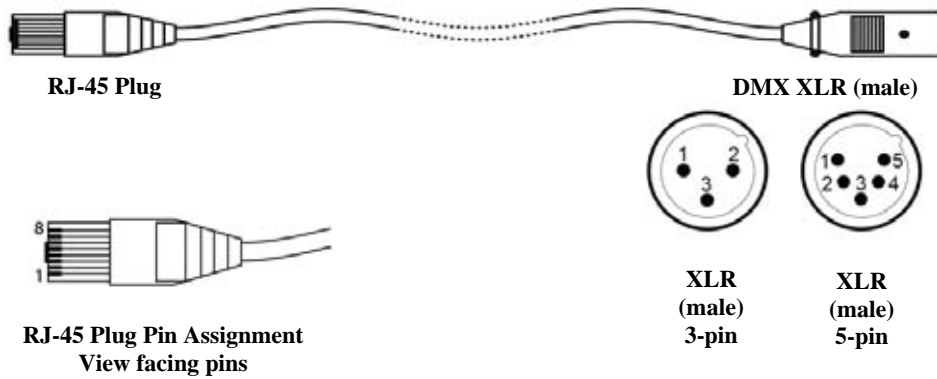

RJ-45 Plug Pin Assignment
View facing pins

RJ-45 Plug	3-pin XLR Male	5-pin XLR Male
Pin 1: Not Used		
Pin 2: Not Used		
Pin 3: Not Used		
Pin 4: Not Used		Pin 4: Not Used
Pin 5: +5 V		Pin 5: Not Used
Pin 6: Data +	Pin 2: Data +	Pin 2: Data +
Pin 7: Data -	Pin 3: Data -	Pin 3: Data -
Pin 8: GND	Pin 1: GND	Pin 1: GND

Signal Patch cable: Used for linking two LQIGIC™ 1X36 products



RJ-45 Plug	RJ-45 Plug
Pin 1: Not Used	Pin 1: Not Used
Pin 2: Not Used	Pin 2: Not Used
Pin 3: Not Used	Pin 3: Not Used
Pin 4: Not Used	Pin 4: Not Used
Pin 5: +5 V	Pin 5: +5 V
Pin 6: Data +	Pin 6: Data +
Pin 7: Data -	Pin 7: Data -
Pin 8: GND	Pin 8: GND

LED Patch Cable: Used to link the LQIGIC™ 1X36 to its devices.



Pin #	Wire Color	Function
1	White/Orange	Red LED +
2	Orange/White	Green LED +
3	White/Green	Blue LED +
4	Blue/White	Not Used
5	White/Blue	Red LED -
6	Green/White	Green LED -
7	White/Brown	Blue LED -
8	Brown/White	Not Used

Mounting

Before mounting this product, read and follow the safety recommendations indicated in the Safety Notes section (page 2 of this manual).

Orientation

Always mount this product in any safe position while making sure that there is adequate room around it for ventilation, configuration, and maintenance.

Installation

The LQGIC™ 1X36 consists of a single product with two (2) mounting points with 5mm holes. ILUMINARC® recommends following the general guidelines below when mounting the LQGIC™ 1X36.

- When selecting an installation location, consider ease of access to the product for operation, programming adjustments, and routine maintenance.
- Never mount the product in places where rain, high humidity, extreme temperature changes, or restricted ventilation may affect it.
- Make sure that the location where you are mounting the product can support its weight. Please see the Technical Specifications section of this manual for the weight requirement of this product.

Procedure

The LQGIC™ 1X36 has two screw holes built into the casing which serve as mounting points. Use 2 screws to attach the products to a flat, dry surface. Make sure that you can access the product for maintenance and programming.

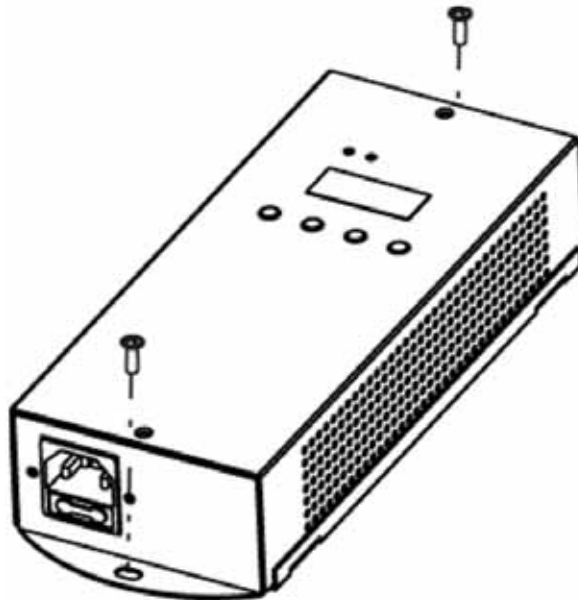

 Make sure to mount this product away from any flammable material as indicated in the Safety Notes.

 Please consult local electrical code compliance and regulations for any additional installation restrictions.

4. Operation

Control Panel Description

Button	Function
<MENU>	Exits from the current menu or function
<SET>	Enables the currently displayed menu or sets the currently selected value in to the current function
<UP>	Navigates upwards through the menu list and increases the numeric value when in a function
<DOWN>	Navigates downwards through the menu list and decreases the numeric value when in a function

Control Options

You can set the LQIC™ 1X36 start address in the 001~512 DMX range. This allows for the control of up to 64 products in the 8-channel **EFFECT** personality.

Programming (RGB Mode)

Refer to the Menu Options section on page 18 to learn how the menu options relate to each other. The Menu Options section has a Main level and a variable number of programming levels for each option.

To go to an option in the Main level, press <MENU> repeatedly until the option shows on the display. Press <SET> to select it. This will take you to the first programming level for that option.

To select an option or value within the current programming level press <UP> or <DOWN> until it shows on the display. Press <SET> to accept it. In this case, if there is another programming level, you will see its first option. Otherwise, you will see the selected value.

To exit to the previous menu level, press <MENU>.

Mode Selection

1. Go to **MENU>SET**.
2. Select **GO RGB?**
3. Select **YES?**

DMX Addressing

1. Go to **MENU>DMX**.
2. Select the starting address [**001~512**].
3. Go to **MENU >RUN**.
4. Select **DMX**.

DMX Personality

1. Go to **MENU>PERSON** and select any DMX personality.
2. Make sure to rearrange the DMX addresses of all products in the current DMX universe to avoid address overlapping.



When running the product using a DMX controller, make sure that the **Menu>Run** is set to **DMX**.

Master/Slave

On the Master product:

1. Go to **MENU>RUN** and select **DMX**.
2. Go to **MENU>AUTO** and select any Auto program.

On each of the Slave products:

1. Go to **MENU>RUN** and select **SLAVE**.

The slave products will follow the program played by the Master.

Static Colors

1. Go to **MENU>STATIC**.
2. Select a color or effect **RED, GREN, BLUE, DIMM, and STRO**.
3. Select a color value **[000~255]** or a strobe frequency **[0~20]**.

Auto Play

1. Go to **MENU>AUTO**.
2. Select a program **RGB [01~10]**.
3. Select a speed **SP [001~255]**.

Custom Play

1. Go to **MENU>CUSTOM**.
2. Select a program **CUSTOM [01~10]**.

Edit Custom

1. Go to **MENU>EDIT**.
2. Select a program **C-[01~10]**.
3. Select a scene **S [01~20]**.
4. Select a color **RED, GREN, or BLUE**.
5. Configure the color value **[000~255]**.
6. Repeat steps 4 and 5 for the other colors.
7. Configure the strobe frequency **STROB [00~20]**.
8. Configure the Step and Fade timers **[000~255]**.
9. Repeat steps 4 to 8 for the other scenes.



AUTO 01~10 are fully configured programs and cannot be modified. However, **CUSTOM 01~10** programs are fully customizable (see Edit Custom).



AUTO 01~10 consist of two (2) different, fully configured programs giving the user a total of twenty(20) different auto programs to choose from.

RGB to W Setting

When **RGB TO W** is active, the product will automatically use the RGB values for a balanced white look. When inactive, the product will use the most powerful intensity.

1. Go to **MENU>SET>RGB TO W**.
2. Select **YES** or **NO**.

Whites Setting

1. Go to **MENU>SET>CALIBRAT**.
2. Select a white color **WHITE 1~9** or **RGB TO W**.
3. Set a color **R**, **G**, and **B**.
4. Configure the color value [**000~255**].
5. Repeat steps 2 thru 4 for the other RGB colors to obtain a white color.

Set Time and Date

1. Go to **MENU>SET>CLOCK**.
2. Set Year, Day Of Week, Day, Month, Hour, Min, and Sec.

Set Schedule

1. Go to **MENU>SCHED**. A day of the week or “**EVERYDAY**” will show on the LCD.
2. Select **DOW** or **EVERYDAY**.
3. Select **NO. 01~10**.
4. Set **CSTM 01~10**, **STATIC**, **RGB 01~10**, or **PL NONE**.
5. Set Start time [**00:00** to **23:59**].
Set End time [**00:00** to **23:59**].

Playing Schedule

1. Go to **MENU>PLAY SCHEDULE**.



The Password is fixed by default. It is not able to be changed.



If the upload is successful, all the products will show "Success" on the LCD.

Password

When KEYLOCK is active, the product will ask you to enter the password (<UP>, <DOWN>, <UP>, and <DOWN>) after 30 seconds of control panel inactivity or upon power up.

1. Go to **MENU >SET**.
2. Select **ON/OFF**.

Upload Customs

1. Set all products that are going to receive the upload to **SLAVE** operation.
2. Disconnect the products from the DMX controller.
3. On the product whose custom programs you are going to copy, got to **MENU >SET** and select **UPLOAD**.
4. Enter the password and press <SET> for the upload to start.

Reset

1. Go to **MENU >SET**.
2. Select **RESET CUS** (resets custom programs), **RESET SCH** (resets schedule), or **RESET ALL** (resets entire product to factory default).
3. When **YES** shows, press <SET>.

Programming (SpectraWhite™ Mode)

Refer to the Menu Options section on page 20 to learn how the menu options relate to each other. The Menu Options section has a Main level and a variable number of programming levels for each option.

To go to an option in the Main level, press <MENU> repeatedly until the option shows on the display. Press <SET> to select it. This will take you to the first programming level for that option.

To select an option or value within the current programming level press <UP> or <DOWN> until it shows on the display. Press <SET> to accept it. In this case, if there is another programming level, you will see its first option. Otherwise, you will see the selected value.

To exit to the previous menu level, press <MENU>.

Mode Selection

1. Go to MENU>SET.
2. Select GO WHITE.
3. Select YES?

DMX Addressing

1. Go to MENU >ADDRES.
2. Select the starting address [001~512].
3. Go to MENU >RUN.
4. Select DMX.

DMX Personality

1. Go to MENU>PERS and select any DMX personality.
2. Make sure to rearrange the DMX addresses of all products in the current DMX universe to avoid address overlapping.

Master/Slave

On the Master product:

1. Go to **MENU>RUN** and select **DMX**.
2. Go to **MENU>MOOD**.
3. Select **COOL**, **WARM**, or **NATURAL**.
4. Select **DIM [000~255]**

On each of the Slave products:

1. Go to **MENU>RUN** and select **SLAVE**.

The slave products will follow the program played by the Master.

Static Colors

1. Go to **MENU>STATIC**.
2. Select a color or effect **COOL**, **WARM**, **DIMM**, and **STRO**.
3. Select a color value **[000~255]** or a strobe frequency **[00~20]**

Auto Play

1. Go to **MENU>MOOD**.
2. Select a program **COOL**, **WARM**, or **NATURAL**.
3. Select **DIM [000~255]**.

Whites Setting

1. Go to **MENU>SET>CALL**.
2. Select a white macro **WHITE [1~5]**.
3. Configure the color value for **WARM** and **COOL [000~255]**.
4. Repeat steps 2 and 3 for the other white macros.

Set Time and Date

1. Go to **MENU>SET>CLOCK**.
2. Set Year, DOW, Day, Month, Hour, Min, and Sec.

Set Schedule

1. Go to **MENU>SCHED**. A day of the week or “**EVERYDAY**” will show on the LCD.
2. Select **DOW** or **EVERYDAY**.
3. Select **NO [01~10]**.
4. Set **WHITE [1~5]** or **PLAY NONE**.
5. Set Start time **[00:00 to 23:59]**.
Set End time **[00:00 to 23:59]**.

Playing Schedule

1. Go to **MENU>PLAY SCHEDULE**.

Password

When KEYLOCK is active, the product will ask you to enter the password (<UP>, <DOWN>, <UP>, and <DOWN>) after 30 seconds of control panel inactivity or upon power up.

1. Go to **MENU >SET**.
2. Select **ON/OFF**.

Reset

1. Go to **MENU>SET**.
2. Select **RESET ALL** (sets product back to factory default settings).
3. When **YES** shows, press <SET>.

Menu Options RGB Mode

Main	Programming Steps			Instructions	
1. Auto	RGB 1~10	SP	1~255	Choose from 10 automatic programs	
2. Custom	CUSTOM 1~10			Choose from 10 user-defined programs	
3. Static	RED		0~255	Configure and/or play a single step program	
	GREN				
	BLUE				
	DIMM				
	STRO	0~20			
4. Play schedule	SCHEDULE PLAYING!			Play scheduled program	
5. DMX	001~512			Sets DMX starting address	
6. Person	EFFECT			8-channel mode	
	RGB			3-channel mode	
	RGB+D			4-channel mode	
	RGB+DMS			6-channel mode	
	SOLID			1-channel mode	
7. Edit	C-1~10 (custom)	S1~20 (scene)	RED GREN BLUE	0~255	Combine Red, Green, and Blue to generate a custom color
			STROB	0~20	Set the strobe frequency
			TIME	0~255	Set the on time
			FADE		Set the fading time
8. Set	PASSWORD		ON/OFF		Turn password protection on after 30 seconds of being idle
	ALLOW EDIT		YES/NO		Reserved for future use
	RSET ALL				Default all settings
	RSET CUS				Erase the custom programs
	RSET SCH				Erase the schedule
	UPLOAD	PASSWORD	[Enter Password]		Transfer custom programs from master to slave products
	CLOCK	EDIT TIM	YEAR	2000~2099	Edit the DOW, date, and time
			DOW	SU~SA	
			DAY	01~31	
			MONTH	00~12	
			HOUR	00~23	
			MIN	00~59	
	SEC				
CALIBRAT	WHITE 1~9	R G B	0~255	Modify the White macros	
	RGB TO WHITE			Configure RGB to WHITE values	
RGB TO WHITE	YES/NO			[Yes]RGB TO WHITE defines output color when RGB faders are at "255" [No]Max. intensity when RGB faders are at "255"	
GO TO WHITE	YES?			Go to SpectraWhite™ mode	

Continues on the next page

Continued from previous page

Main	Programming Steps			Instructions	
9. Run	DMX			Work with a DMX controller	
	SLAVE			Slave mode	
	EASY PLAY			Optional remote	
10. Sched	SUNDAY~ SATURDA Y (Different schedules for each DOW)	No.1~10	RGB CUSTOM	1~10	After selecting DOW, schedule #, and program, enter starting and ending time [00:00~23:59]
	EVERYDA Y (Same schedule for every DOW)		STATIC		
	PLAY NONE				
11. Patch	K1~6	RGB CSTM	1~10	For future usage	

Menu Options SpectraWhite™ Mode

Main	Programming Steps			Instructions	
1. Mood	WARM	DIM	1~255	Choose a white effect and intensity	
	NATURAL				
	COOL				
2. Static	COOL		0~255	Configures and/or plays a single step program per output line	
	WARM				
	DIMME				
	STROB				
3. Play schedule	SCHEDULE PLAYING!			Play scheduled program	
4. Address	001-512			Sets DMX starting address	
5. Person	STUD W			2-channel mode	
	STUD W+D			3-channel mode	
	STUD 1			2-channel mode	
	STUD 2			4-channel mode	
	SOLID			1-channel mode	
6. Set	PASSWORD		ON/OFF	Turns password protection on after 30 seconds of being idle	
	RESET		YES/NO	Defaults all settings	
	CALL	WHITE 1-5	WARM	0~255	Modify the White macros
			COOL		
	CLOCK	EDIT TIM	YEAR	2000~2099	Edit the DOW, date, and time
			DOW	SA~SU	
			DAY	01~31	
			MONTH	01~12	
			HOUR	00~23	
			MIN	00~59	
SEC					
GO TO RGB		YES?		Go to RGB mode	
7. Run	DMX			Work with a DMX controller	
	SLAVE			Slave mode with Master product	
8. Schedu	SUNDAY~ SATURDAY (Different schedules for each DOW)	No. 1-10	WHITE 1-5	After selecting DOW, schedule #, and white macro; enter starting and ending time [00:00~23:59]	
	EVERYDAY (Same schedule every DOW)		PL NONE		

DMX Values RGB Mode

EFFECT

Channel	Function	Value	Percent/Setting
1	Red	000 ⇔ 255	0~100%
	Step Time		When CUS. 01-10 in CH. 7 is activated
2	Green	000 ⇔ 255	0~100%
	Step Time		When CUS. 01-10 in CH. 7 is activated
3	Blue	000 ⇔ 255	0~100%
4	Dimmer	000 ⇔ 255	0~100%
5	Color Macro + White Balance	000 ⇔ 010	No Function
		011 ⇔ 035	R: 100% G: Up B: 0%
		036 ⇔ 060	R: Down G: 100% B: 0%
		061 ⇔ 085	R: 0% G: 100% B: Up
		086 ⇔ 110	R: 0% G: Down B: 100%
		111 ⇔ 135	R: Up G: 0% B: 100%
		136 ⇔ 160	R: 100% G: 0% B: Down
		161 ⇔ 185	R: 100% G: Up B: Up
		186 ⇔ 210	R: Down G: Down B: 100%
		211 ⇔ 215	White 1: 3,200 K
		216 ⇔ 220	White 2: 3,400 K
		221 ⇔ 225	White 3: 4,200 K
		226 ⇔ 230	White 4: 4,900 K
		231 ⇔ 235	White 5: 5,600 K
		236 ⇔ 240	White 6: 5,900 K
		241 ⇔ 245	White 7: 6,500 K
246 ⇔ 250	White 8: 7,200 K		
251 ⇔ 255	White 9: 8,500 K		
6	Strobe	000 ⇔ 004	No Function
		005 ⇔ 255	0~20 Hz
7	Auto + Custom Programs	000 ⇔ 020	No function
		021 ⇔ 030	Auto RGB 1
		031 ⇔ 040	Auto RGB 2
		041 ⇔ 050	Auto RGB 3
		051 ⇔ 060	Auto RGB 4
		061 ⇔ 070	Auto RGB 5
		071 ⇔ 080	No Function
		081 ⇔ 090	No Function
		091 ⇔ 100	No Function
		101 ⇔ 110	No Function
		111 ⇔ 120	No Function
		121 ⇔ 130	Custom 1
		131 ⇔ 140	Custom 2
		141 ⇔ 150	Custom 3
		151 ⇔ 160	Custom 4
		161 ⇔ 170	Custom 5
171 ⇔ 180	Custom 6		
181 ⇔ 190	Custom 7		
191 ⇔ 200	Custom 8		
201 ⇔ 210	Custom 9		
211 ⇔ 220	Custom 10		
221 ⇔ 255	No function		
8	Auto Programs Speed	000 ⇔ 255	Slow~fast

DMX Values RGB Mode (Cont.)

RGB

Channel	Function	Value	Percent/Setting
1	Red	000 ⇔ 255	0~100%
2	Green	000 ⇔ 255	0~100%
3	Blue	000 ⇔ 255	0~100%

RGB + D

Channel	Function	Value	Percent/Setting
1	Red	000 ⇔ 255	0~100%
2	Green	000 ⇔ 255	0~100%
3	Blue	000 ⇔ 255	0~100%
4	Dimmer	000 ⇔ 255	0~100%

RGB + DMS

Channel	Function	Value	Percent/Setting
1	Red	000 ⇔ 255	0~100%
2	Green	000 ⇔ 255	0~100%
3	Blue	000 ⇔ 255	0~100%
4	Dimmer	000 ⇔ 255	0~100%
5	Color Macro + White Balance	000 ⇔ 010	No Function
		011 ⇔ 035	R: 100% G: Up B: 0%
		036 ⇔ 060	R: Down G: 100% B: 0%
		061 ⇔ 085	R: 0% G: 100% B: Up
		086 ⇔ 110	R: 0% G: Down B: 100%
		111 ⇔ 135	R: Up G: 0% B: 100%
		136 ⇔ 160	R: 100% G: 0% B: Down
		161 ⇔ 185	R: 100% G: Up B: Up
		186 ⇔ 210	R: Down G: Down B: 100%
		211 ⇔ 215	White 1: 3,200 K
		216 ⇔ 220	White 2: 3,400 K
		221 ⇔ 225	White 3: 4,200 K
		226 ⇔ 230	White 4: 4,900 K
231 ⇔ 235	White 5: 5,600 K		
236 ⇔ 240	White 6: 5,900 K		
241 ⇔ 245	White 7: 6,500 K		
246 ⇔ 250	White 8: 7,200 K		
251 ⇔ 255	White 9: 8,500 K		
6	Strobe	000 ⇔ 004	No Function
		005 ⇔ 255	0~20 Hz

SOLID

Channel	Function	Value	Percent/Setting
1	Master Dimmer	000 ⇔ 255	0~100%

DMX Values SpectraWhite™ Mode

STUD W

Channel	Function	Value	Percent/Setting
1	Warm White	000 ⇔ 255	0~100%
2	Cool White	000 ⇔ 255	0~100%

STUD W+D

Channel	Function	Value	Percent/Setting
1	Dimmer	000 ⇔ 255	0~100%
2	Warm White	000 ⇔ 255	0~100%
3	Cool White	000 ⇔ 255	0~100%

STUD 1

Channel	Function	Value	Percent/Setting
1	Dimmer	000 ⇔ 255	0~100%
2	White Macro	000 ⇔ 050 051 ⇔ 080 081 ⇔ 110 111 ⇔ 140 141 ⇔ 255	White 1: 3200 K White 2: 3400 K White 3: 4500 K White 4: 4900 K White 5: 5600 K

STUD 2

Channel	Function	Value	Percent/Setting
1	Master Dimmer	000 ⇔ 255	0~100%
2	Warm White	000 ⇔ 255	0~100%
3	Cool White	000 ⇔ 255	0~100%
4	White Macro	000 ⇔ 050 051 ⇔ 080 081 ⇔ 110 111 ⇔ 140 141 ⇔ 255	White 1: 3200 K White 2: 3400 K White 3: 4500 K White 4: 4900 K White 5: 5600 K
5	Strobe	000 ⇔ 255	0~20 Hz

SOLID

Channel	Function	Value	Percent/Setting
1	Dimmer	000 ⇔ 255	0~100%

5. Technical Information

System Maintenance

To maintain optimum performance and minimize wear, the user should clean the product frequently. Usage and environment are contributing factors in determining the cleaning frequency. As a rule, the user should clean the product at least twice a month. Dust build up reduces light output performance and can cause overheating. This can lead to reduced light source life and increased mechanical wear.

The cleaning frequency depends on the environment in which the product operates. Damp, smoky, or particularly dirty surrounding can cause greater accumulation of dirt on the product's optics.

To clean a product, follow the recommendations below:

- Unplug the product from power.
- Wait until the product has cooled.
- Use a vacuum (or dry compressed air) and a soft brush to remove dust collected on the external vents and reachable internal components.
- Apply the solution directly to the cloth or tissue and drag any dirt and grime to the outside of the product.



If the product has fans, make sure that you never spin a fan if cleaning the product with compressed air.

Product Repairs

ILUMINARC® strongly advises you against attempting any repairs to this product unless you are an authorized ILUMINARC® technician.

ILUMINARC® presents the information contained in the Troubleshooting Table as a guide only. In most cases, opening the product's housing will invalidate its warranty, unless there is a written indication to the contrary.



Always dry the external optics and glass surfaces carefully after cleaning them.



If you still experience technical problems after trying the solutions in the Troubleshooting Table, contact ILUMINARC® Technical Support.

Troubleshooting Guide

Symptom	Cause(s)	Action(s)
General low light intensity	Dirty lens assembly	Clean the product regularly
	Misaligned lens assembly	Return for service to Iluminarc®
No LED illuminates	Faulty LED PCB	Return for service to Iluminarc®
	Faulty LED patch cable	Return for service to Iluminarc®
	Faulty LED driver	Return for service to Iluminarc®
One LED does not illuminate	Faulty LED	Return for service to Iluminarc®
	Faulty LED patch cable	Return for service to Iluminarc®
	Faulty LED driver	Return for service to Iluminarc®
Circuit breaker/fuse keeps tripping/blowing	Excessive circuit load	Check total load placed on the electrical circuit
	Short circuit along the power wires	Check for a short in the electrical wiring
Product does not power up	No power	Check for power on power outlet
	Loose or damaged power cord	Check power cord
	Blown fuse	Replace fuse
	Faulty internal power supply	Return for service to Iluminarc
Product does not respond to DMX	Wrong DMX addressing	Check Control Panel and product addressing
	Damaged DMX cables	Check DMX cables
	Wrong polarity on the controller	Check polarity switch settings on the controller
	Loose DMX cables	Check cable connections
	Faulty DMX interface	Return for service to Iluminarc
	Faulty Display/Main board	Return for service to Iluminarc
DMX signal problems	Non DMX cables	Use only DMX compatible cables
	Bouncing signals	Install terminator as suggested
	Long cable / low level signal	Install an optically coupled DMX splitter right after the product with the strong signal
	Too many products	Install an optically coupled DMX splitter after product #32 or before
	Interference from AC wires	Keep DMX cables separated from power cables or fluorescent/black lights

LED Disclaimer

LED Life

ILUMINARC® rates LED lifetime based on lumen depreciation of 70% of the original output, with data provided by the manufacturer of the LED. Data from the manufacturer of the LED are not independently verified or measured by ILUMINARC®. When the product is operating in optimal environmental conditions, the LED lifetime is rated to be 50,000 to 70,000 hours by the LED manufacturer.

LED Binning

LED manufacturers sort LEDs into “bins”, based on variances in color, output intensity and the frequency at which the semiconductor operates. ILUMINARC® strives to hold its LED manufacturers to the highest standards of binning to optimize consistency in output from product to product. However, the availability of a single bin cannot be guaranteed. With that in mind, ILUMINARC® has developed a rigorous control system to seek the best achievable consistency in color and output.

Color Rendering Index (CRI)

CRI is an industry standard method to compare properties of different types of light sources. There are known limitations and inconsistencies related to CRI. Results may vary depending on the environmental factors involved. For this reason, the US Department of Energy (DOE) states that CRI should be considered as one point of reference among others in evaluating white LED products and systems.

The following is an excerpt of recommendations from the DOE:

1. Identify the visual tasks to be performed under the light source. If color fidelity under different light sources is critically important (for example, in a space where color or fabric comparisons are made under both daylight and electric lighting), CRI values may be a useful metric for rating LED products.
2. CRI may be compared only for light sources of equal CCT. This applies to all light sources, not only to LEDs. Also, differences in CRI values of less than five points are not significant, e.g., light sources with 80 and 84 CRI are essentially the same.
3. If color appearance is more important than color fidelity, do not exclude white light LEDs solely on the basis of relatively low CRI values. Some LED products with CRIs as low as 25 still produce visually pleasing white light.
4. Evaluate LED systems in person and, if possible, on-site when color fidelity or color appearance are important issues.

Source: DOE publication: PNNL-SA-56891, January 2008

Returns Procedure

The user must send the merchandise prepaid, in the original box, and with its original packing and accessories. ILUMINARC® will not issue call tags.

Call ILUMINARC® and request a Return Merchandise Authorization Number (RMA#) before shipping the product. Be prepared to provide the model number, serial number, and a brief description of the cause for the return.

The user must clearly label the package with a Return Merchandise Authorization Number (RMA#). ILUMINARC® will refuse any product returned without a RMA#.

Once you receive the RMA#, please include the following information on a piece of paper inside the box:

- Your name
- Your address
- Your phone number
- The RMA#
- A brief description of the problem

Be sure to pack the product properly. Any shipping damage resulting from inadequate packaging will be the customer's responsibility. As a suggestion, proper FedEx packing or double-boxing is the shipping method ILUMINARC® recommends.

Claims

The carrier is responsible for any damage incurred during shipping. Therefore, if the received merchandise appears to have damages caused during shipping, the customer must submit the damage report and any related claims with the carrier, not ILUMINARC®. The customer must submit the report upon reception of the damaged merchandise. Failure to do so in a timely manner may invalidate the customer's claim with the carrier.

For other issues such as missing components or parts, damage not related to shipping, or concealed damage, the customer must make claims to ILUMINARC® within seven (7) days of receiving the merchandise.

Contact Us

World Wide

General Information

ILUMINARC®
 5200 NW 108th Avenue
 Sunrise, FL 33351
 Voice: (954) 923-3680
 Fax: (954) 929-5571
 Email: info@iluminarc.com

Customer Support

Voice: (954) 923-3680 (ext. 4000)
 Fax: (954) 756-8015
 Email: tech@iluminarc.com

World Wide Web

www.iluminarc.com



DO NOT write the RMA# directly on the box. Instead, write it on a properly affixed label.



ILUMINARC® reserves the right to use its own discretion to repair or replace returned product(s).



Always keep the original box and all packaging material as you will need those to ship the product back to ILUMINARC®.

Technical Specifications

Dimensions and Weight	Length	Width	Height	Weight
	9.8 in (250 mm)	3.9 in (100 mm)	2.0 in (50 mm)	1.95lbs (.88 kg)

Note: Dimensions in inches rounded to the nearest decimal digit.

Electrical	Power Supply Type	Range	Voltage Selection
	Switching (internal)	100~240 V, 50/60 Hz	Auto-ranging
	Parameter	120 V, 60 Hz	230 V, 50 Hz
	Consumption	58 W (0.5 A)	58 W (0.3 A)
	Inrush current	N/A	N/A
	Power I/O	Input	Output
	Connectors	IEC	N/A
	Cord plug	Edison	N/A
Light Source	Type	Power	Lifespan
	N/A	N/A	N/A
	Color	Quantity	Current
	Determined by Product	N/A	N/A
Photo Optic	Parameter	Optics	
	Illuminance @ 5 m	N/A	
	Beam angle	N/A	
	Field angle	N/A	
Thermal	Max. External Temperature	Cooling System	
	104° F (40° C)	Convection	
DMX	I/O Connectors	Connector Type	Channel Range
	CAT 5	Sockets	1, 2, 3, 4, 5, 6, 8
Ordering	LQIC™ 1X36		
	31x36001		



